

TEST REPORT

Report No.: BCTC2310567797E

Applicant: Vincent Medical Excel Limited

Product Name: Red Light Tower

Test Model: RLC - VM

Tested Date: 2023-10-20 to 2023-11-07

Issued Date: 2024-03-06



Shenzhen **BCTC** Testing Co., Ltd.

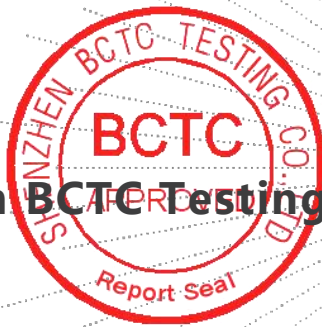

Product Name: Red Light Tower
Trademark: Clearlight
Model/Type Reference: RLC - VM
Prepared For: Vincent Medical Excel Limited
Address: Units 1604-07A, 16/F., Two Harbourfront, 22 Tak Fung Street, Hung Hom, Kowloon, Hong Kong
Manufacturer: Vincent Medical(Dongguan)Technology Company Limited
Address: RM 101 And 201, Block 10, 1st Taoyuan Road, Songshan Lake Zone, Dongguan 523808, Guangdong P.R. China
Prepared By: Shenzhen BCTC Testing Co., Ltd.
Address: 1-2/F., Building B, Pengzhou Industrial Park, No.158, Fuyuan 1st Road, Zhancheng, Fuhai Subdistrict, Bao'an District, Shenzhen, Guangdong, China.
Sample Received Date: 2023-10-20
Sample Tested Date: 2023-10-20 to 2023-11-07
Issue Date: 2024-03-06
Report No.: BCTC2310567797E
Test Standards: EN IEC 55014-1:2021, EN IEC 55014-2:2021
EN IEC 61000-3-2:2019+A1:2021, EN 61000-3-3:2013+A2:2021
Test Results: PASS

Tested by:



Lucas Chan /Project Handler

Approved by:



Zero Zhou/Reviewer

The test report is effective only with both signature and specialized stamp. This result(s) shown in this report refer only to the sample(s) tested. Without written approval of Shenzhen BCTC Testing Co., Ltd, this report can't be reproduced except in full. The tested sample(s) and the sample information are provided by the client.

Table Of Content

Test Report Declaration	Page
1. Version	5
2. Test Summary	6
3. Measurement Uncertainty	7
4. Product Information And Test Setup.....	8
4.1 Product Information.....	8
4.2 Test Setup Configuration	8
4.3 Support Equipment	8
4.4 Test Mode	9
5. Test Facility And Test Instrument Used.....	10
5.1 Test Facility.....	10
5.2 Test Instrument Used.....	10
6. Disturbance Voltages	12
6.1 Block Diagram Of Test Setup.....	12
6.2 Limit	12
6.3 Test procedure.....	12
6.4 Test Result.....	13
7. Radiated Disturbance Test.....	15
7.1 Block Diagram Of Test Setup.....	15
7.2 Limits.....	15
7.3 Test Procedure	15
7.4 Test Results	16
8. Harmonic Current Emission(H).....	18
8.1 Block Diagram Of Test Setup.....	18
8.2 Limit	18
8.3 Test Procedure	18
8.4 Test Results	19
9. Voltage Fluctuations & Flicker(F)	22
9.1 Block Diagram of Test Setup	22
9.2 Limit	22
9.3 Test Procedure	22
9.4 Test Results	23
10. Immunity Test Of General The Performance Criteria	24
11. Electrostatic Discharge Immunity Test (ESD).....	25
11.1 Test Specification.....	25
11.2 Block Diagram of Test Setup	25
11.3 Test Procedure	25
11.4 Test Results.....	26
12. Fast Transients Immunity Test (EFT).....	27
12.1 Test Specification.....	27
12.2 Block Diagram of EUT Test Setup.....	27
12.3 Test Procedure	27
12.4 Test Results	27
13. Surges Immunity Test.....	28
13.1 Test Specification.....	28
13.2 Block Diagram of EUT Test Setup	28



13.3	Test Procedure	28
13.4	Test Result.....	29
14.	Injected Currents Immunity Test (CS)	30
14.1	Test Specification.....	30
14.2	Block Diagram of EUT Test Setup	30
14.3	Test Procedure	30
14.4	Test Result.....	30
15.	Voltage Dips And Interruptions Immunity Test (DIPS).....	31
15.1	Test Specification.....	31
15.2	Block Diagram of EUT Test Setup	31
15.3	Test Procedure	31
15.4	Test Result.....	31
16.	EUT Photographs.....	32
17.	EUT Test Setup Photographs.....	38

(Note: N/A Means Not Applicable)

TE
TC
OVE
t Sea

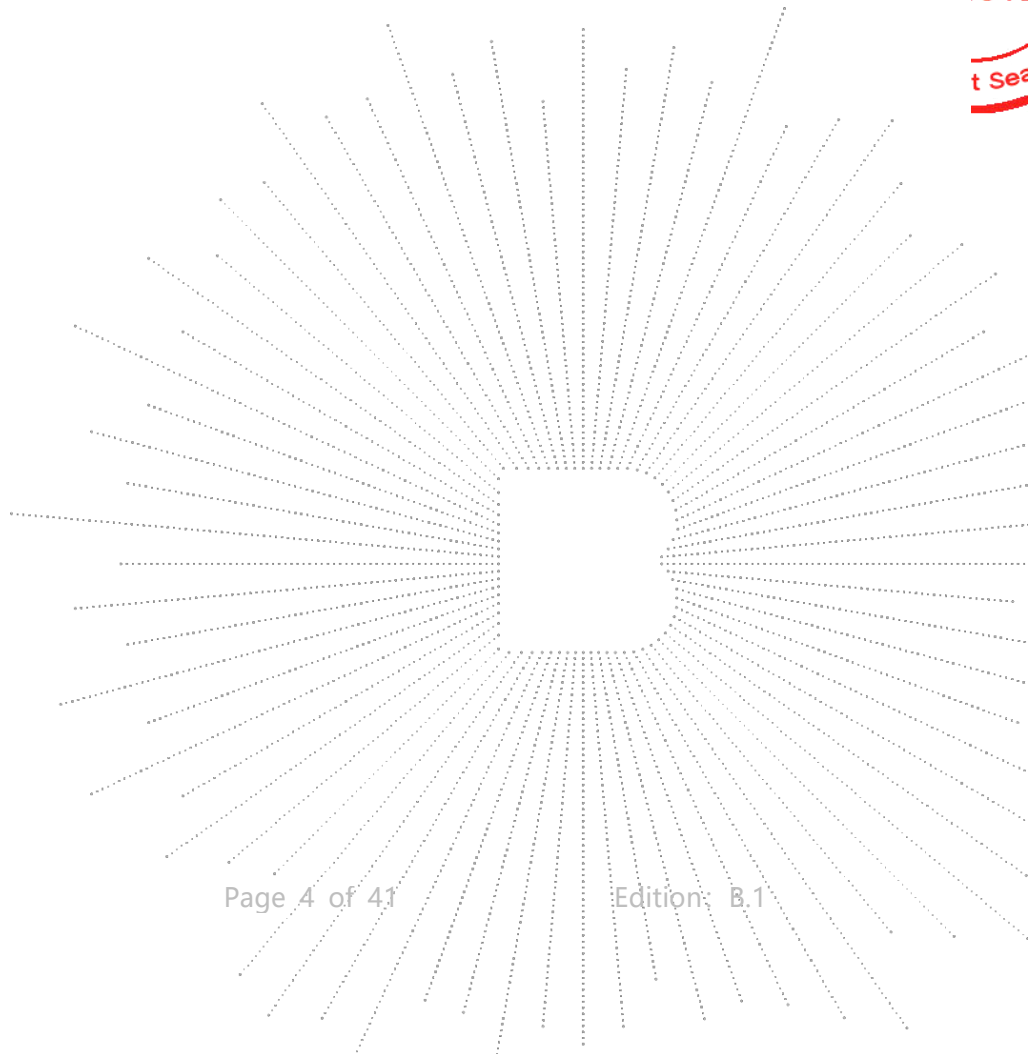

1. Version

Report No.	Issue Date	Description	Approved
BCTC2310567797E	2024-03-06	Original	Valid

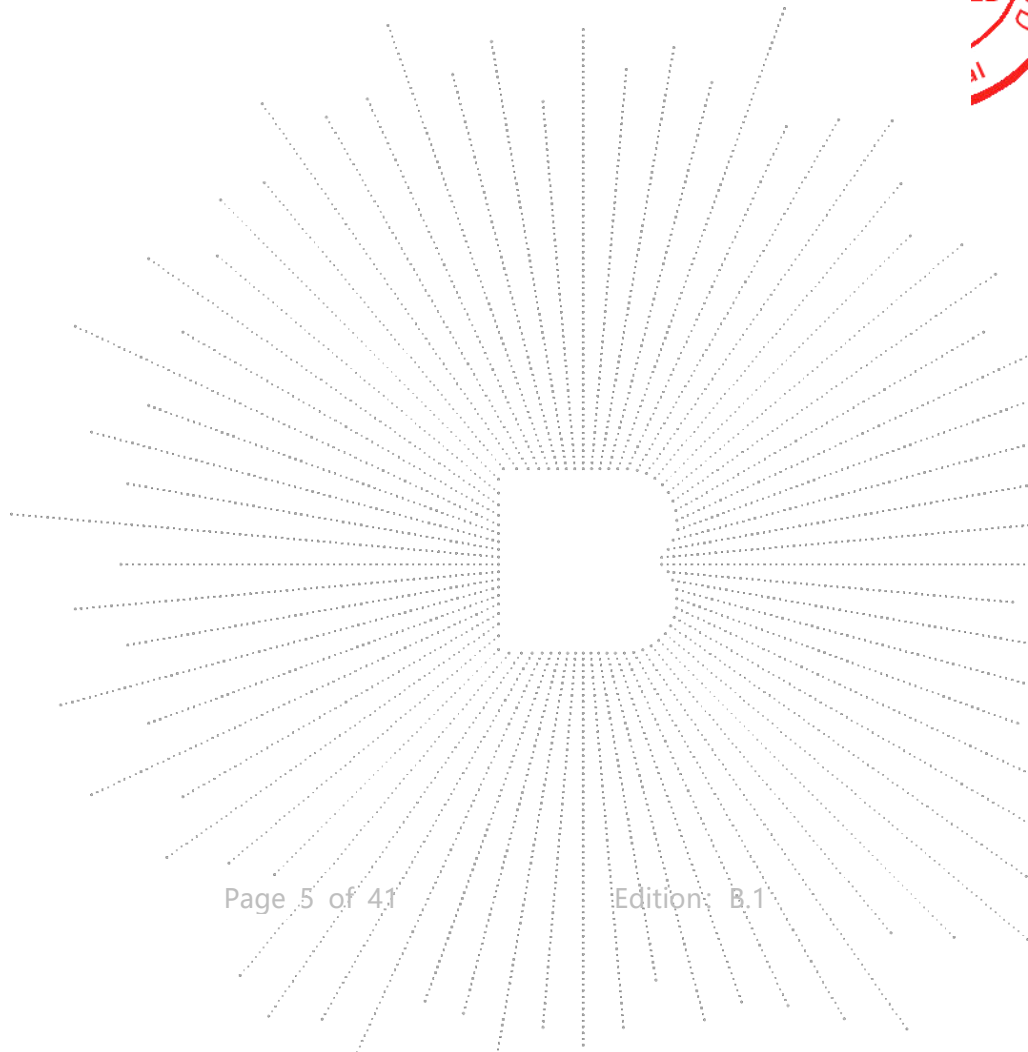

2. Test Summary

The Product has been tested according to the following specifications:

EMISSION		
Standard	Test Item	Test result
EN IEC 55014-1	Disturbance voltages(CE)	Pass
EN IEC 55014-1	Discontinuous disturbance (Clicks)	N/A ¹
EN IEC 55014-1	Disturbance power(DP)	N/A ²
EN IEC 55014-1	Magnetic field induced current in a 2m loop antenna(ME)	N/A ³
EN IEC 55014-1	Magnetic field strength	N/A ³
EN IEC 55014-1	Radiated disturbance (RE)	Pass
EN IEC 61000-3-2	Harmonic current emission(H)	Pass
EN 61000-3-3	Voltage fluctuations & flicker(F)	Pass

IMMUNITY (EN 55014-2)		
Standard	Test Item	Test result
IEC 61000-4-2	Electrostatic discharge immunity Test (ESD)	Pass
IEC 61000-4-3	Radio frequency electromagnetic fields(RS)	N/A ⁴
IEC 61000-4-4	Fast transients immunity Test (EFT)	Pass
IEC 61000-4-5	Surges immunity Test	Pass
IEC 61000-4-6	Injected currents immunity Test (CS)	Pass
IEC 61000-4-11	Voltage dips and interruptions immunity Test (DIPS)	Pass

Remark:

1. The Product has no switching operations, automatic programme or other electrically controlled or operated functions
2. The Product shall be evaluated for emissions in the 30 MHz to 1 000 MHz range by testing in accordance with method b as described in clause 4.3.4.2 of EN IEC 55014-1.
3. It only apply to induction cooking appliances.
4. Mains operated equipment containing electronic control circuitry with no clock frequency higher than 15 MHz, no testing required.
5. The Product belongs to Class A, and its power is less than 75W, so it deems to fulfil this standard without testing.

3. Measurement Uncertainty

Where relevant, the following measurement uncertainty levels have been estimated for tests performed on the Product as specified in CISPR 16-4-2. This uncertainty represents an expanded uncertainty expressed at approximately the 95% confidence level using a coverage factor of $k=2$.

Test item	Value (dB)
Disturbance voltages (150K-30MHZ)	3.10
Disturbance power(DP)	4.40
Radiated disturbance (30MHz-200MHz)	4.60
Radiated disturbance (200MHz-1000MHz)	5.20

4. Product Information And Test Setup

4.1 Product Information

Ratings:
(Radiated disturbance)

The highest frequency of the internal sources of the EUT is (less than 108)MHz:

(Radio frequency electromagnetic fields)

The clock frequency of the internal sources of the EUT is (less than 15)MHz:

Input: 100-240V/200W/2A

 less than 108 MHz, the measurement shall only be made up to 1 GHz.

 between 108 MHz and 500 MHz, the measurement shall only be made up to 2 GHz.

 between 500 MHz and 1 GHz, the measurement shall only be made up to 5 GHz.

 above 1 GHz, the measurement shall be made up to 5 times the highest frequency or 6 GHz, whichever is less.

 Mains operated equipment containing electronic control circuitry with no clock frequency higher than 15 MHz, no testing required.

 Mains operated equipment containing electronic control circuitry with a highest clock frequency greater than 15 MHz but lower than or equal to 200 MHz, the measurement shall only be made up to 1 GHz.

 Mains operated equipment containing electronic control circuitry with a highest clock frequency greater than 200 MHz, the measurement shall be made up to 6 GHz.

Cable Of Product

No.	Cable Type	Quantity	Provider	Length (m)	Specification	Note
1	--	--	Applicant	---	Shielded	With a ferrite ring in mid Detachable
2	--	--	BCTC	--	Unshielded	--

4.2 Test Setup Configuration

See test photographs attached in EUT TEST SETUP Photographs for the actual connections between Product and support equipment.

4.3 Support Equipment

No.	Device Type	Brand	Model	Series No.	Note
1.	---	---	---	---	---

Notes:

1. All the equipment/cables were placed in the worst-case configuration to maximize the emission during the test.

2. Grounding was established in accordance with the manufacturer's requirements and conditions for the intended use.



4.4 Test Mode

Test item	Test Mode	Test Voltage
Disturbance voltages(150KHz-30MHz)	Working	AC 230V/50Hz
Radiated disturbance(30MHz-1GHz)	Working	AC 230V/50Hz
Voltage fluctuations & flicker(F)	Working	AC 230V/50Hz
Electrostatic discharge (ESD) B <input checked="" type="checkbox"/> Air Discharge: $\pm 8\text{kV}$ <input checked="" type="checkbox"/> Contact Discharge: $\pm 4\text{kV}$ <input checked="" type="checkbox"/> HCP & VCP: $\pm 4\text{Kv}$ 10 times each point/	Working	AC 230V/50Hz
Electrical fast transients/burst (EFT) <input checked="" type="checkbox"/> 1kV AC(Input) <input type="checkbox"/> 0.5kV DC(Input) <input type="checkbox"/> 1kV signal,Telec,control	Working	AC 230V/50Hz
Surges <input checked="" type="checkbox"/> Line-Line, 1KV <input checked="" type="checkbox"/> 2kV Line-PE, N-PE <input type="checkbox"/> 0.5kVDC(Input) <input type="checkbox"/> 1KV, <input type="checkbox"/> 2KV signal, Telec, control C	Working	AC 230V/50Hz
Injected Currents (CS) A 0.15MHz to 230MHz 3V <input checked="" type="checkbox"/> AC(Input) <input type="checkbox"/> DC(Input) <input type="checkbox"/> signal, control	Working	AC 230V/50Hz
Voltage dips and interruptions (DIPS) 0% 0.5P C 40% 200ms C 70% 500ms C	Working	AC 230V/50Hz

BCTC
 BCTC
 PPR
 Report

5. Test Facility And Test Instrument Used

5.1 Test Facility

All measurement facilities used to collect the measurement data are located at Shenzhen BCTC Testing Co., Ltd. Address: 1-2/F., Building B, Pengzhou Industrial Park, No.158, Fuyuan 1st Road, Zhancheng, Fuhai Subdistrict, Bao'an District, Shenzhen, Guangdong, China. The site and apparatus are constructed in conformance with the requirements of ANSI C63.4 and CISPR 16-1-1 other equivalent standards.

5.2 Test Instrument Used

Disturbance voltagesTest					
Equipment	Manufacturer	Model#	Serial#	Last Cal.	Next Cal.
Receiver	R&S	ESR3	102075	May 15, 2023	May 14, 2024
LISN	R&S	ENV216	101375	May 15, 2023	May 14, 2024
Software	Frad	EZ-EMC	EMC-CON 3A1	\	\

Radiated Emissions Test (966 Chamber#01)					
Equipment	Manufacturer	Model#	Serial#	Last Cal.	Next Cal.
966 chamber	ChengYu	966 Room	966	May 15, 2023	May 14, 2026
Receiver	R&S	ESRP	101154	May 15, 2023	May 14, 2024
Receiver	R&S	ESR3	102075	May 15, 2023	May 14, 2024
Amplifier	SKET	LAPA_01G18 G-45dB	SK202104090 1	May 15, 2023	May 14, 2024
Amplifier	Schwarzbeck	BBV9744	9744-0037	May 15, 2023	May 14, 2024
TRILOG Broadband Antenna	schwarzbeck	VULB9163	942	May 29, 2023	May 28, 2024
Horn Antenna	schwarzbeck	BBHA9120D	1541	May 31, 2023	May 30, 2024
Software	Frad	EZ-EMC	FA-03A2 RE	\	\

Harmonic / Flicker Test					
Equipment	Manufacturer	Model#	Serial#	Last Cal.	Next Cal.
Harmonic & Flicker Tester	LAPLAEC	AC2000A	439263	May 15, 2023	May 14, 2024
AC Power Supply	KIKUSUI	PCR4000M	UK001879	May 15, 2023	May 14, 2024
Software	HTEC	H/F	V1.5	\	\

Electrostatic Discharge Test					
Equipment	Manufacturer	Model#	Serial#	Last Cal.	Next Cal.
ESD Tester	KIKUSUI	KES4201A	UH002321	May 15, 2023	May 14, 2024

Continuous RF Electromagnetic Field Disturbances Test					
Equipment	Manufacturer	Model#	Serial#	Last Cal.	Next Cal.
Power meter	Keysight	E4419	A00065	May 15, 2023	May 14, 2024
Power sensor	Keysight	E9300A	US39211659	May 15, 2023	May 14, 2024
Power sensor	Keysight	E9300A	US39211305	May 15, 2023	May 14, 2024
Amplifier	SKET	HAP_801000-250W	21201805013	May 15, 2023	May 14, 2024
Amplifier	SKET	HAP_0103-75W	21201805014	May 15, 2023	May 14, 2024
Amplifier	SKET	HAP_0306-50W	21201805015	May 15, 2023	May 14, 2024
Stacked double Log.-Per. Antenna	Schwarzbeck	STLP 9129	00077	\	\
Field Probe	Narda	EP-601	611WX80256	May 15, 2023	May 14, 2024
Signal Generato	Agilent	N5181A	MY50143748	May 15, 2023	May 14, 2024
Software	SKET	EMC-S	1.2.0.18	\	\

EFT And Surge And Voltage Dips And Interruptions Test					
Equipment	Manufacturer	Model#	Serial#	Last Cal.	Next Cal.
Compact Generato	TRANSIENT	TRA2000	646	May 15, 2023	May 14, 2024
Coupling Clamp	PARTNER	CN-EFT1000	CN-EFT1000-1624	May 15, 2023	May 14, 2024

Continuous Induced RF Disturbances Test					
Equipment	Manufacturer	Model#	Serial#	Last Cal.	Next Cal.
C/S Test System	SCHLODER	CDG-6000-75	126B1405/2016	May 15, 2023	May 14, 2024
Attenuator	SCHLODER	6DB DC-1G	HA1630	May 15, 2023	May 14, 2024
CDN	SCHLODER	CDN M2+M3	A2210389/2016	May 15, 2023	May 14, 2024
Injectio n	SCHLOBER	EMCL-20	132A1272/2016	May 15, 2023	May 14, 2024
Software	HUBERT	HUBERTEN 61000-4-6	1.4.1.0	\	\



6. Disturbance Voltages

6.1 Block Diagram Of Test Setup

For mains ports:

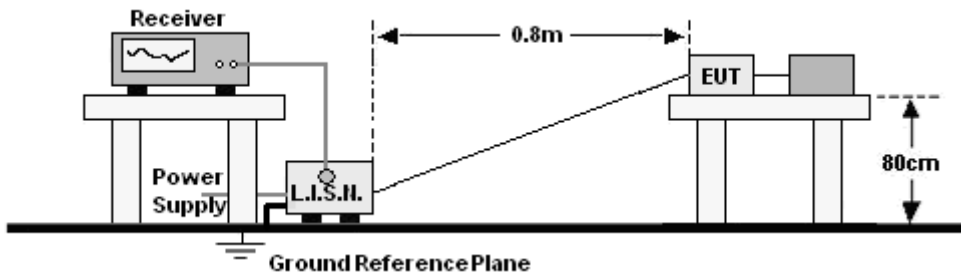

6.2 Limit

At mains ports Limits for Household Appliance

Frequency (MHz)	Limits dB(μ V)	
	Quasi-peak	Average
0,15 ~ 0,50	66 ~ 56*	59 ~ 46*
0.50 ~ 5.00	56	46
5.00 ~ 30.00	60	50

Notes: 1. *Decreasing linearly with logarithm of frequency.
2. The lower limit shall apply at the transition frequencies.

6.3 Test procedure

For mains ports:

- The Product was placed on a nonconductive table 0.8m above the horizontal ground reference plane, and 0.4 m from the vertical ground reference plane, and connected to the main through Line Impedance Stability Network (L.I.S.N).
- The RBW of the receiver was set at 9 kHz in 150 kHz ~ 30MHz with Peak and AVG detector in Max Hold mode. Run the receiver's pre-scan to record the maximum disturbance generated from Product in all power lines in the full band.
- For each frequency whose maximum record was higher or close to limit, measure its QP and AVG values and record.

6.4 Test Result

Temperature:	26 °C	Relative Humidity:	54%
Pressure:	101kPa	Phase :	Line
Test Voltage :	AC 230V/50Hz	Test Mode:	Working

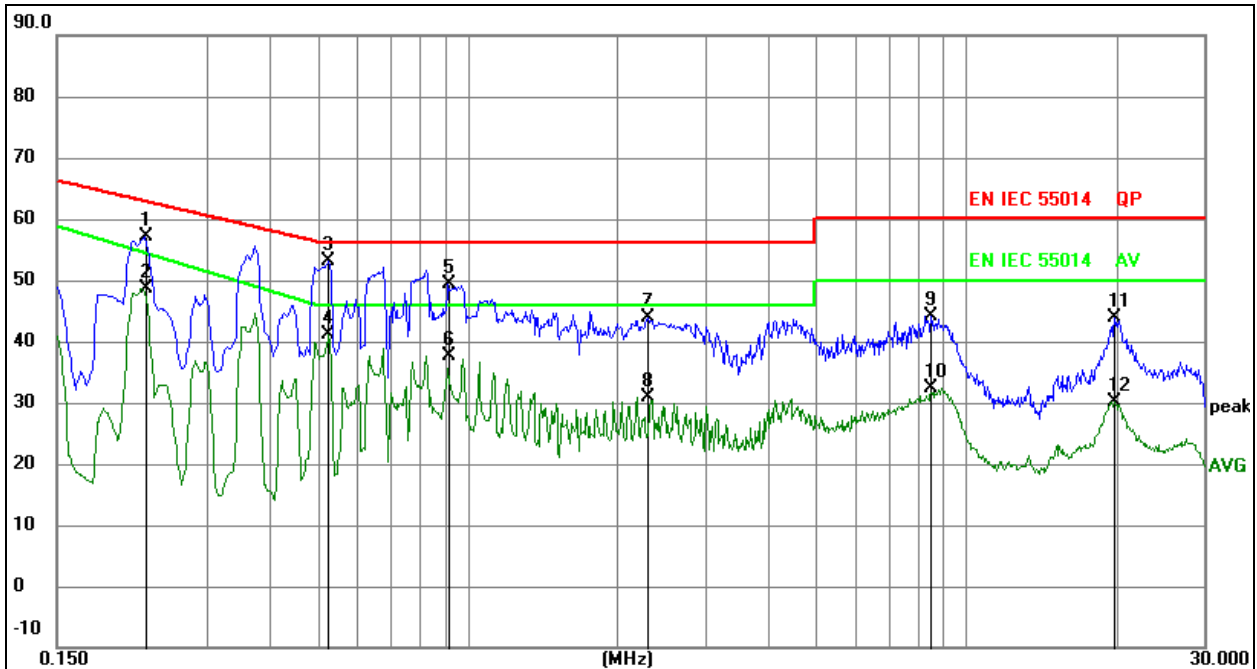

Remark:

1. All readings are Quasi-Peak and Average values.
2. Factor = Insertion Loss + Cable Loss.
3. Measurement = Reading Level + Correct Factor
4. Over = Measurement - Limit

No.	Mk.	Freq.	Reading Level	Correct Factor	Measurement	Limit	Over	Detector
		MHz		dB	dBuV	dBuV	dB	
1		0.2256	37.31	19.83	57.14	62.61	-5.47	QP
2		0.2256	28.72	19.83	48.55	54.59	-6.04	AVG
3	*	0.5265	33.31	19.84	53.15	56.00	-2.85	QP
4		0.5265	21.38	19.84	41.22	46.00	-4.78	AVG
5		0.9136	29.35	19.92	49.27	56.00	-6.73	QP
6		0.9136	17.78	19.92	37.70	46.00	-8.30	AVG
7		2.2967	23.71	20.06	43.77	56.00	-12.23	QP
8		2.2967	10.77	20.06	30.83	46.00	-15.17	AVG
9		8.5011	24.25	19.92	44.17	60.00	-15.83	QP
10		8.5011	12.34	19.92	32.26	50.00	-17.74	AVG
11		19.8445	23.81	19.99	43.80	60.00	-16.20	QP
12		19.8445	10.13	19.99	30.12	50.00	-19.88	AVG

SHENZHEN

Temperature:	26 °C	Relative Humidity:	54%
Pressure:	101kPa	Phase :	Neutral
Test Voltage :	AC 230V/50Hz	Test Mode:	Working

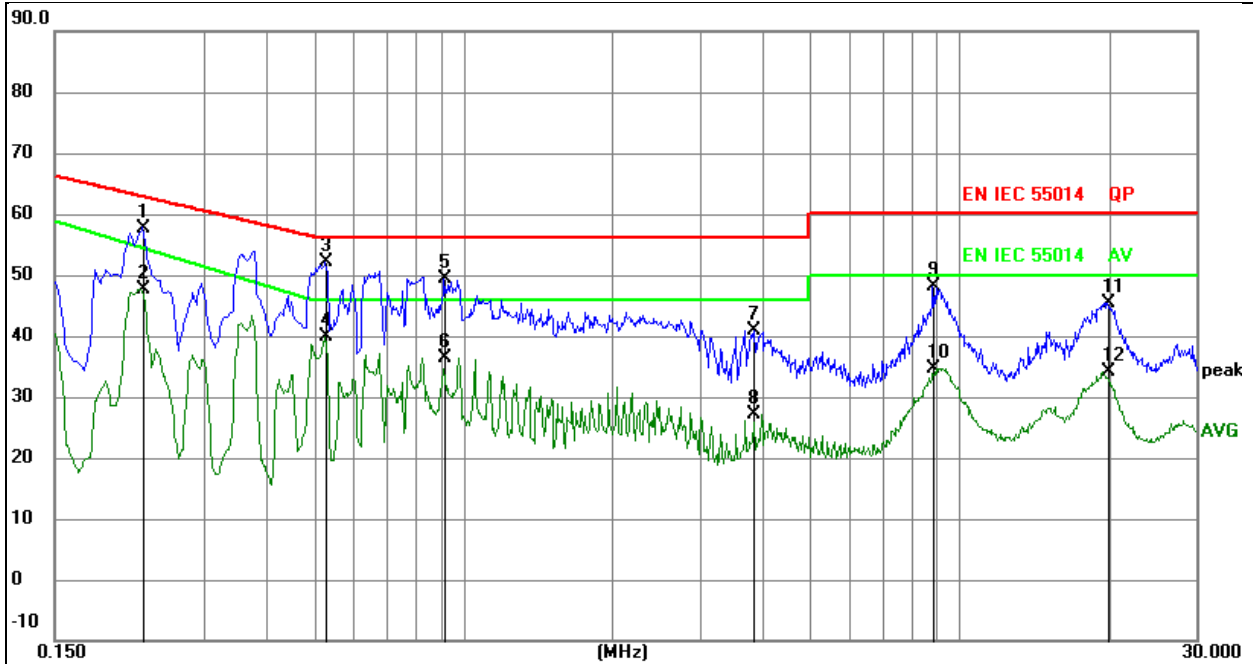
Remark:

1. All readings are Quasi-Peak and Average values.
2. Factor = Insertion Loss + Cable Loss.
3. Measurement = Reading Level + Correct Factor
4. Over = Measurement - Limit

No.	Mk.	Freq. MHz	Reading Level	Correct Factor dB	Measure- ment dBuV	Limit dBuV	Over dB	Detector
1		0.2265	37.92	19.83	57.75	62.58	-4.83	QP
2		0.2265	27.87	19.83	47.70	54.55	-6.85	AVG
3	*	0.5280	32.17	19.84	52.01	56.00	-3.99	QP
4		0.5280	20.02	19.84	39.86	46.00	-6.14	AVG
5		0.9150	29.50	19.92	49.42	56.00	-6.58	QP
6		0.9150	16.48	19.92	36.40	46.00	-9.60	AVG
7		3.8580	20.37	20.61	40.98	56.00	-15.02	QP
8		3.8580	6.51	20.61	27.12	46.00	-18.88	AVG
9		8.8395	28.27	19.91	48.18	60.00	-11.82	QP
10		8.8395	14.78	19.91	34.69	50.00	-15.31	AVG
11		19.9229	25.37	19.99	45.36	60.00	-14.64	QP
12		19.9229	14.10	19.99	34.09	50.00	-15.91	AVG

7. Radiated Disturbance Test

7.1 Block Diagram Of Test Setup

Floor Stand

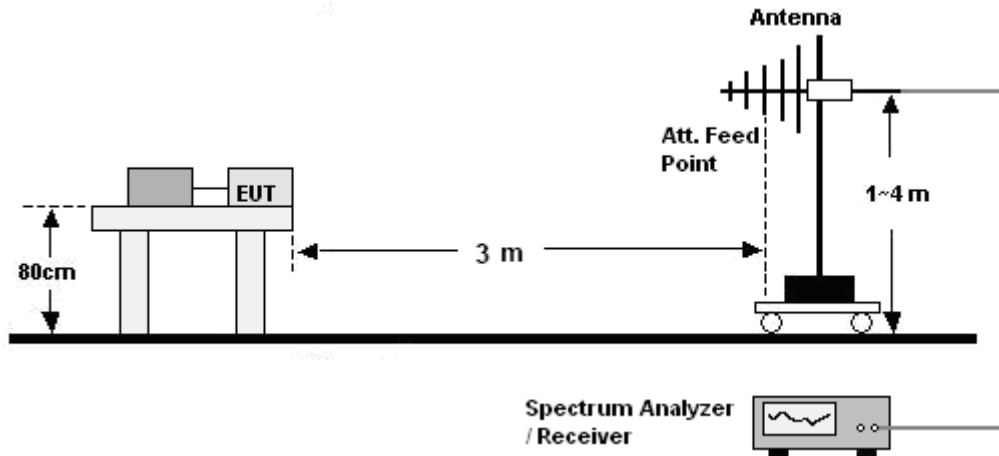

7.2 Limits

Frequency (MHz)	Quasi-peak limits at 3m dB(μ V/m)
30-230	40
230-1000	47

Note: The lower limit shall apply at the transition frequencies.

7.3 Test Procedure

- The Product was placed on the nonconductive turntable 0.8m above the ground at a chamber.
- Set the spectrum analyzer/receiver in Peak detector, Max Hold mode, and 120 kHz RBW. Record the maximum field strength of all the pre-scan process in the full band when the antenna is varied between 1~4 m in both horizontal and vertical, and the turntable is rotated from 0 to 360 degrees.
- For each frequency whose maximum record was higher or close to limit, measure its QP value; vary the antenna's height and rotate the turntable from 0 to 360 degrees to find the height and degree where Product radiated the maximum emission, then set the test frequency analyzer/receiver to QP Detector and specified bandwidth with Maximum Hold Mode, and record the maximum value.

7.4 Test Results

Temperature:	26 °C	Relative Humidity:	54%
Pressure:	101KPa	Phase :	Horizontal
Test Voltage :	AC 230V/50Hz	Test Mode:	Working

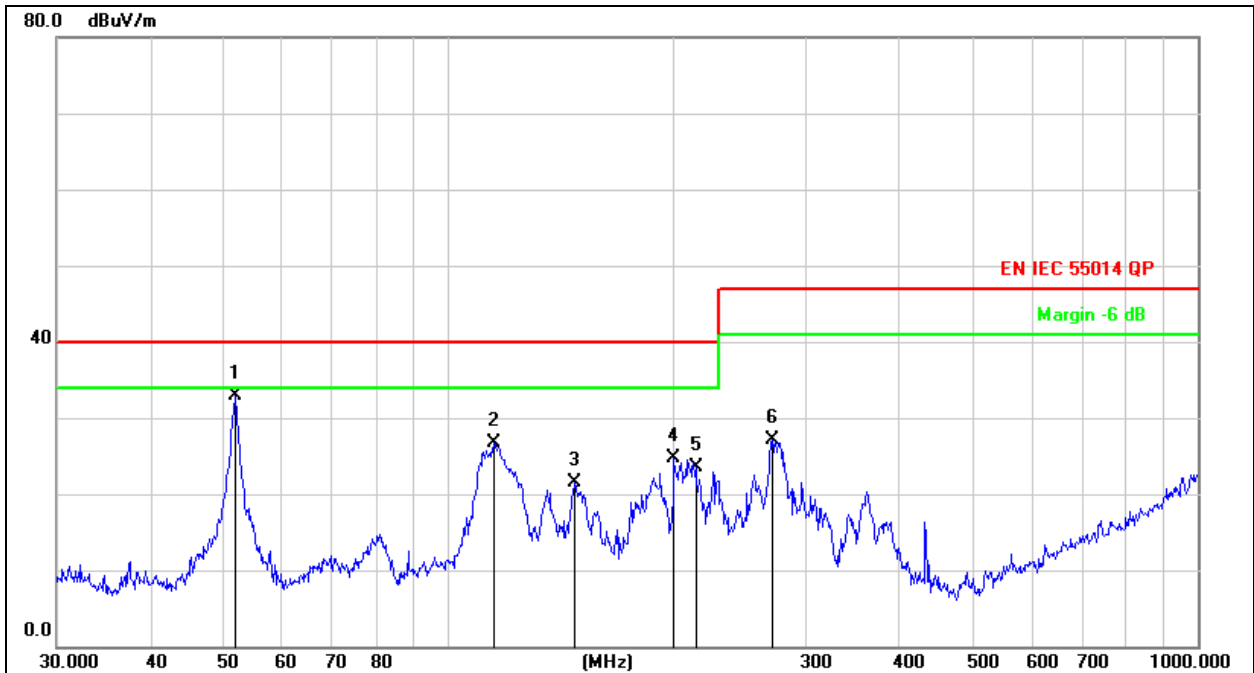

Remark:
 1. Factor = Antenna Factor + Cable Loss – Pre-amplifier.
 2. Measurement = Reading Level + Correct Factor
 3. Over = Measurement - Limit

No.	Mk.	Freq.	Reading Level	Correct Factor	Measurement	Limit	Over	Detector
		MHz	dBuV	dB	dBuV/m	dB/m	dB	
1	*	52.0251	49.79	-16.82	32.97	40.00	-7.03	QP
2		114.9169	41.22	-14.51	26.71	40.00	-13.29	QP
3		147.4036	35.08	-13.60	21.48	40.00	-18.52	QP
4		199.9856	38.79	-14.02	24.77	40.00	-15.23	QP
5		213.7634	38.11	-14.59	23.52	40.00	-16.48	QP
6		270.3748	44.42	-17.41	27.01	47.00	-19.99	QP

Temperature:	26 °C	Relative Humidity:	54%
Pressure:	101KPa	Phase :	Vertical
Test Voltage :	AC 230V/50Hz	Test Mode:	Working

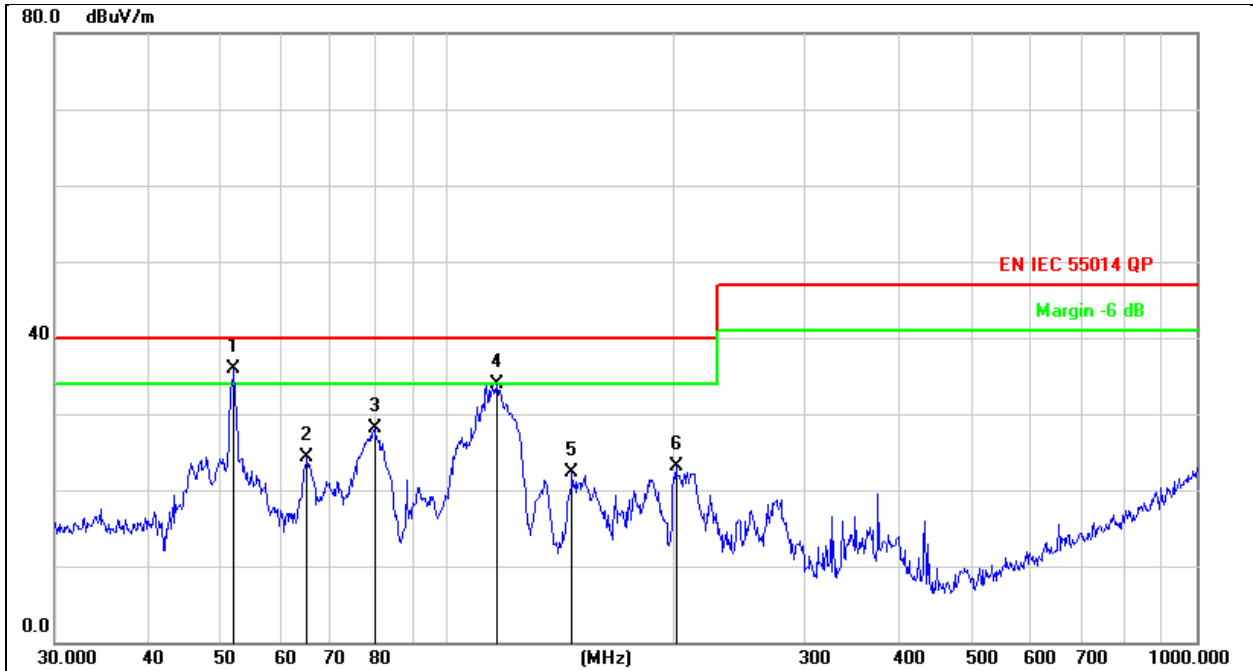

Remark:

1. Factor = Antenna Factor + Cable Loss – Pre-amplifier.
2. Measurement = Reading Level + Correct Factor
3. Over = Measurement - Limit

No.	Mk.	Freq.	Reading Level	Correct Factor	Measurement	Limit	Over	Detector
		MHz	dBuV	dB	dBuV/m	dB/m	dB	
1	*	52.0251	52.81	-16.82	35.99	40.00	-4.01	QP
2		65.1145	40.82	-16.45	24.37	40.00	-15.63	QP
3		80.0806	44.11	-15.94	28.17	40.00	-11.83	QP
4		116.5400	48.38	-14.47	33.91	40.00	-6.09	QP
5		146.8875	35.84	-13.62	22.22	40.00	-17.78	QP
6		202.1005	37.19	-14.11	23.08	40.00	-16.92	QP

8. Harmonic Current Emission(H)

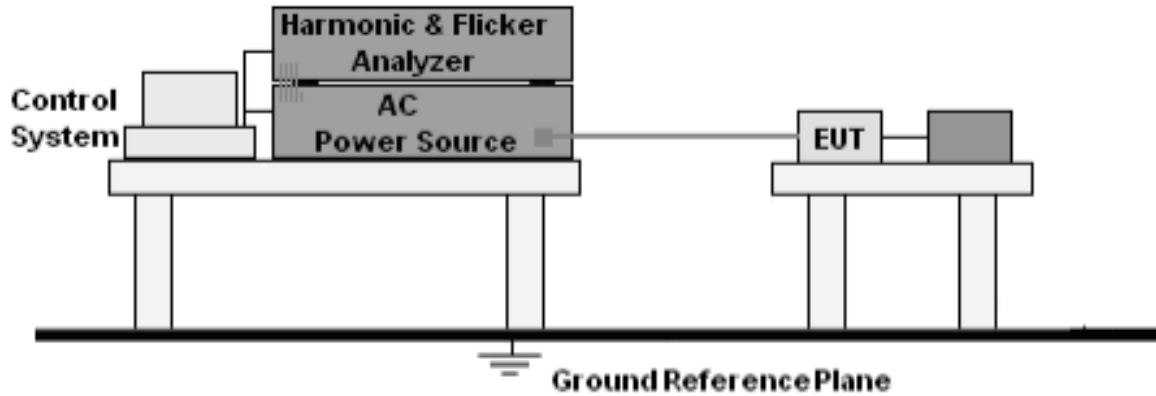
8.1 Block Diagram Of Test Setup



8.2 Limit

EN IEC 61000-3-2:2019+A1:2021

8.3 Test Procedure

- The Product was placed on the top of a non-conductive table above the ground and operated to produce the maximum harmonic components under normal operating conditions for each successive harmonic component in turn.
- The correspondent test program of test instrument to measure the current harmonics emanated from Product was chosen. The measure time shall be not less than the time necessary for the Product to be exercised.

8.4 Test Results

Temperature:	26 °C	Relative Humidity:	54%
Pressure:	101kPa	Test Mode:	Working
Test Voltage :	AC 230V/50Hz		

Test duration (sec):150

Describe:

Test Result: **pass** Source qualification(Power Off Load): **Idle - Pass**

Current & voltage waveforms

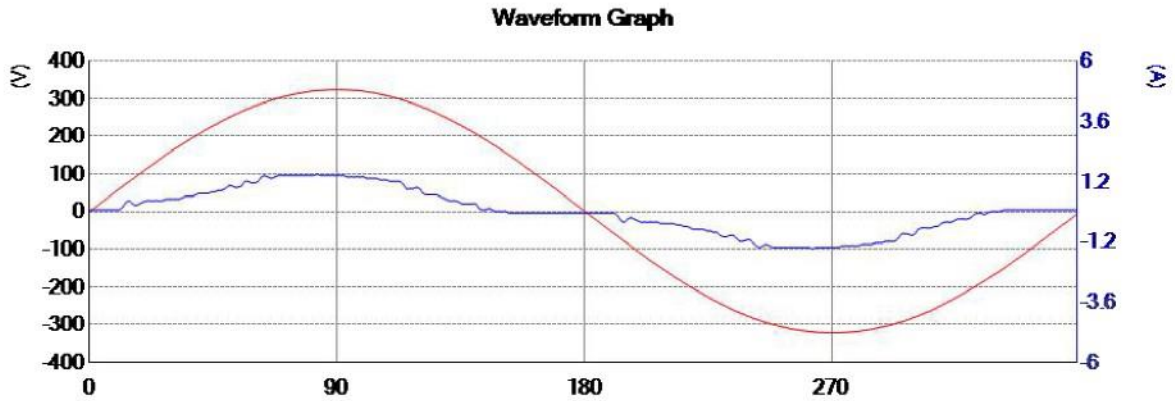

Harmonics and Class A

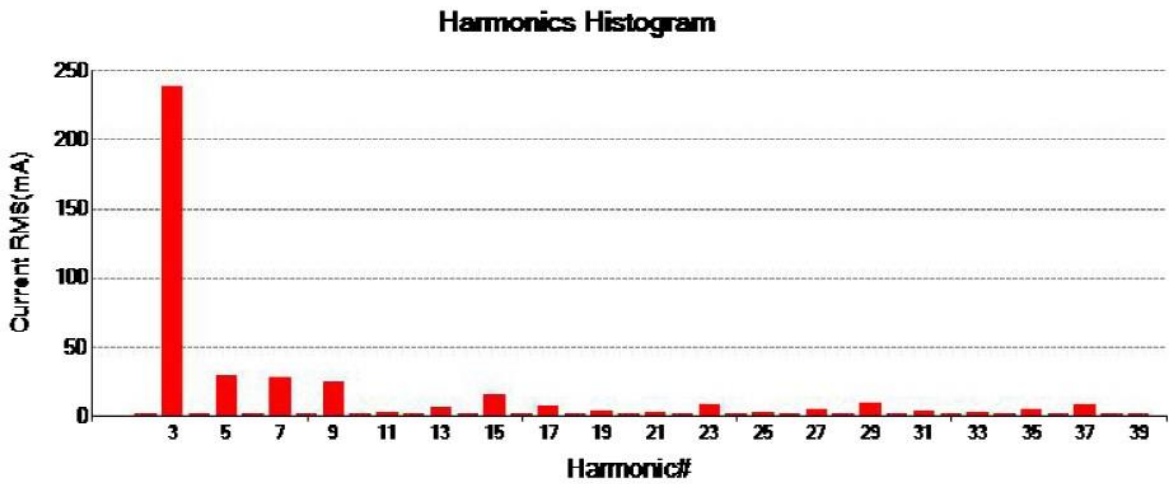

Test duration (sec):150

Describe:

 Test Result: **pass** Source qualification(Power Off Load): **Idle - Pass**

THC(mA): 244.900 I - THD(%): 29.2 POHC(mA):16.900 POHC Limit(mA):251.353

Parameter values during test:

V_RMS (Volts): 230.0

Frequency(Hz): 50.0

I_RMS (A): 0.9

Crest Factor: 1.665

Power (Watts): 190.2

Power Factor: 0.944

Harm#	Harms(filtered) (mA)	Limit (mA)	Harms(avg) (mA)	100%Limit	Harms(max) (mA)	150%Limit	Status
I_Fund	839.100						
2	1.000	1080.000	1.000	0.093	1.200	0.074	Pass
3	238.900	2300.000	238.800	10.383	239.100	6.930	Pass
4	0.500	430.000	0.500	0.116	0.700	0.109	Pass
5	29.100	1140.000	29.200	2.561	29.400	1.719	Pass
6	0.500	300.000	0.500	0.167	0.500	0.111	Pass
7	27.300	770.000	27.500	3.571	28.000	2.424	Pass
8	0.500	230.000	0.500	0.217	0.500	0.145	Pass
9	24.600	400.000	24.700	6.175	25.100	4.183	Pass
10	0.500	184.000	0.500	0.272	0.700	0.254	Pass
11	2.300	330.000	2.500	0.758	3.000	0.606	Pass
12	0.500	153.300	0.500	0.326	0.700	0.304	Pass
13	5.500	210.000	5.700	2.714	6.100	1.937	Pass
14	0.300	131.400	0.400	0.304	0.500	0.254	Pass
15	15.400	150.000	15.500	10.333	15.600	6.933	Pass
16	0.300	115.000	0.400	0.348	0.700	0.406	Pass
17	7.300	132.400	7.400	5.589	7.500	3.776	Pass
18	0.300	102.200	0.500	0.489	0.500	0.326	Pass
19	3.900	118.400	4.000	3.378	4.300	2.421	Pass
20	0.500	92.000	0.500	0.543	0.700	0.507	Pass
21	2.500	107.100	2.500	2.334	2.600	1.618	Pass
22	0.500	83.600	0.500	0.598	0.500	0.399	Pass
23	8.000	97.800	8.100	8.282	8.400	5.726	Pass
24	0.700	76.700	0.500	0.652	0.700	0.608	Pass
25	1.900	90.000	1.700	1.889	1.900	1.407	Pass
26	0.500	70.800	0.500	0.706	0.700	0.659	Pass
27	4.400	83.300	4.400	5.282	4.400	3.521	Pass
28	0.700	65.700	0.500	0.761	0.700	0.710	Pass
29	8.800	77.600	9.000	11.598	9.300	7.990	Pass
30	0.700	61.300	0.600	0.979	0.700	0.761	Pass
31	3.500	72.600	3.600	4.959	3.700	3.398	Pass
32	0.500	57.500	0.600	1.043	0.700	0.812	Pass
33	2.800	68.200	2.800	4.106	3.200	3.128	Pass
34	0.700	54.100	0.600	1.109	0.700	0.863	Pass
35	4.800	64.300	4.700	7.309	5.000	5.184	Pass
36	0.700	51.100	0.600	1.174	0.700	0.913	Pass
37	7.700	60.800	7.600	12.500	7.900	8.662	Pass
38	0.700	48.400	0.700	1.446	0.800	1.102	Pass
39	1.600	57.700	1.300	2.253	1.600	1.849	Pass
40	0.700	46.000	0.800	1.739	0.800	1.159	Pass

Note: All harmonics are below the minimum limits and are ignored.



Test duration (sec):150

Describe:

 Source qualification(Power Off Load): **Pass**

Measurements are compliant with IEC/EN61000-3-2 Ed. 4 & IEC/EN61000-4-7 Ed. 2.1

	Nominal	Measured		Deviation	Allowed Deviation	Result
		Low	High			
Supply Voltage	230	230.02	230.05	0.05	4.6	Pass
Supply Frequency	50	50.0	50.0	0.0	0.25	Pass
Crest Phase	90.0	90.2	90.8	0.8	87 - 93	N/A
Crest Factor	1.414	1.411	1.412	0.003	1.40 - 1.42	N/A
Fundamental Voltage	230.03	-	-	-	-	-

Harm#	Harmonics Voltage	Harmonic Ratio	Limit	Result
2	0.070	0.031	0.200	Pass
3	0.350	0.158	0.900	Pass
4	0.020	0.011	0.200	Pass
5	0.130	0.060	0.400	Pass
6	0.010	0.005	0.200	Pass
7	0.100	0.045	0.300	Pass
8	0.010	0.008	0.200	Pass
9	0.010	0.008	0.200	Pass
10	0.010	0.010	0.100	Pass
11	0.070	0.029	0.100	Pass
12	0.010	0.005	0.100	Pass
13	0.010	0.015	0.100	Pass
14	0.020	0.010	0.100	Pass
15	0.010	0.005	0.100	Pass
16	0.010	0.008	0.100	Pass
17	0.020	0.016	0.100	Pass
18	0.010	0.008	0.100	Pass
19	0.040	0.021	0.100	Pass
20	0.010	0.005	0.100	Pass
21	0.030	0.018	0.100	Pass
22	0.000	0.005	0.100	Pass
23	0.070	0.031	0.100	Pass
24	0.000	0.000	0.100	Pass
25	0.030	0.021	0.100	Pass
26	0.000	0.002	0.100	Pass
27	0.040	0.026	0.100	Pass
28	0.000	0.001	0.100	Pass
29	0.070	0.034	0.100	Pass
30	0.000	0.001	0.100	Pass
31	0.020	0.012	0.100	Pass
32	0.000	0.003	0.100	Pass
33	0.040	0.021	0.100	Pass
34	0.010	0.005	0.100	Pass
35	0.040	0.021	0.100	Pass
36	0.000	0.005	0.100	Pass
37	0.090	0.044	0.100	Pass
38	0.000	0.003	0.100	Pass
39	0.040	0.022	0.100	Pass
40	0.000	0.001	0.100	Pass

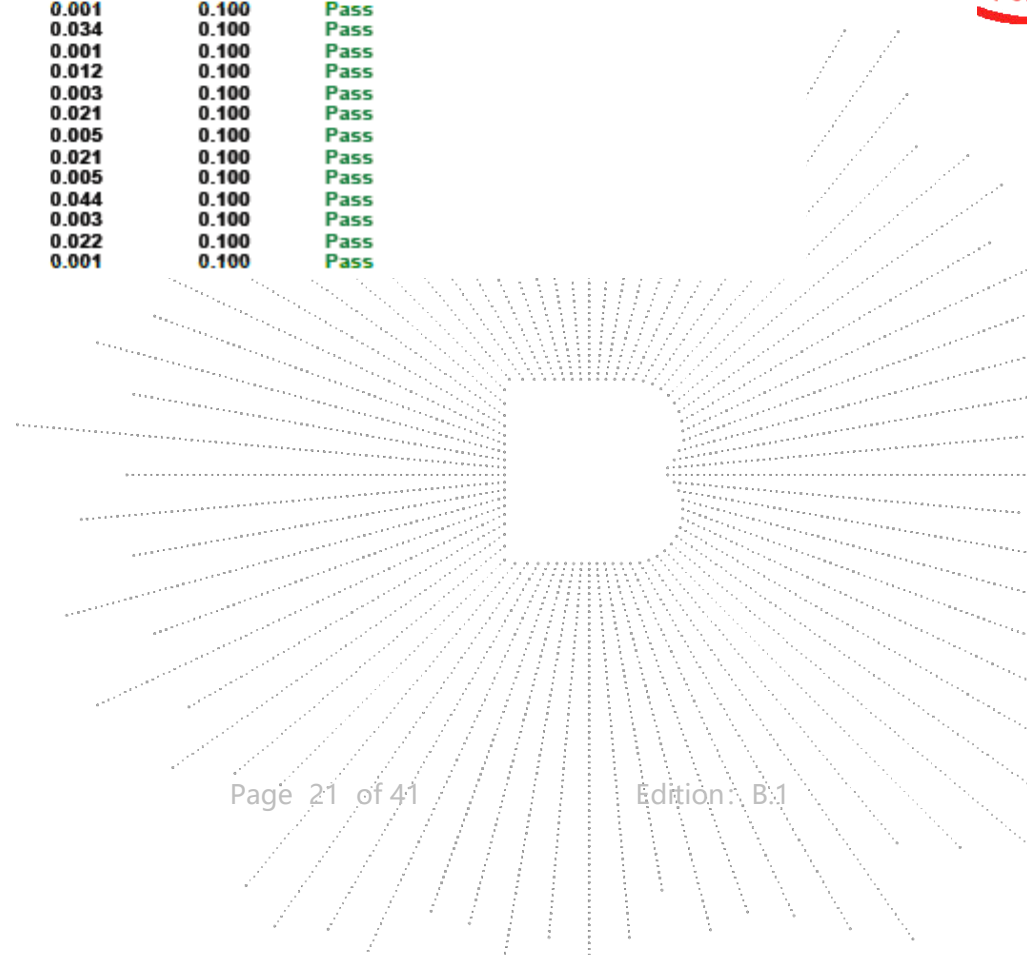
 BCTC
 BCTC
 PPR
 Report

9. Voltage Fluctuations & Flicker(F)

9.1 Block Diagram of Test Setup

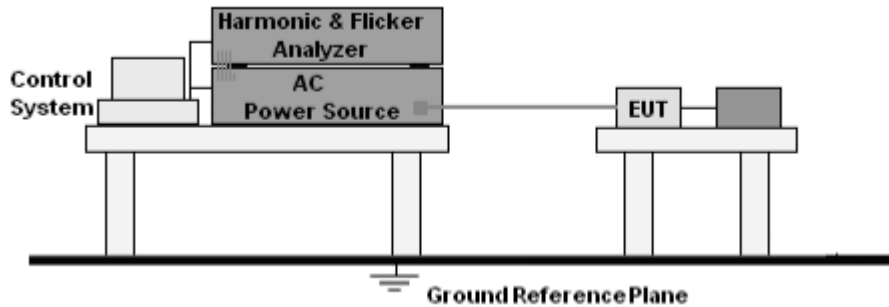

9.2 Limit

EN 61000-3-3:2013+A2:2021 Clause 5.

9.3 Test Procedure

- The Product was placed on the top of a non-conductive table above the ground and operated to produce the most unfavorable sequence of voltage changes under normal operating conditions.
- During the flick test, the measure time shall include that part of whole operation cycle in which the Product produce the most unfavorable sequence of voltage changes. The observation period for short-term flicker indicator is 10 minutes and the observation period for long-term flicker indicator is 2 hours.

9.4 Test Results

Temperature:	26 °C	Relative Humidity:	54%
Pressure:	101kPa	Test Mode:	Working
Test Voltage :	AC 230V/50Hz		

Test duration (sec):600
Describe:
Load Power : 0.189 kW
Power Factor:0.940
Load Current : 0.871 Arms
Crest Factor:1.666
Nominal Voltage : 230.00 Vrms
Test Result: pass
Status: Test Completed
Result:

T-max (ms):	0.00	Test limit (ms):	500.00	Pass
Highest dc (%):	0.00	Test limit (%):	3.30	Pass
Highest dmax (%):	0.00	Test limit (%):	4.00	Pass
Highest Pst (10 min. period):	0.00	Test limit:	1.00	Pass

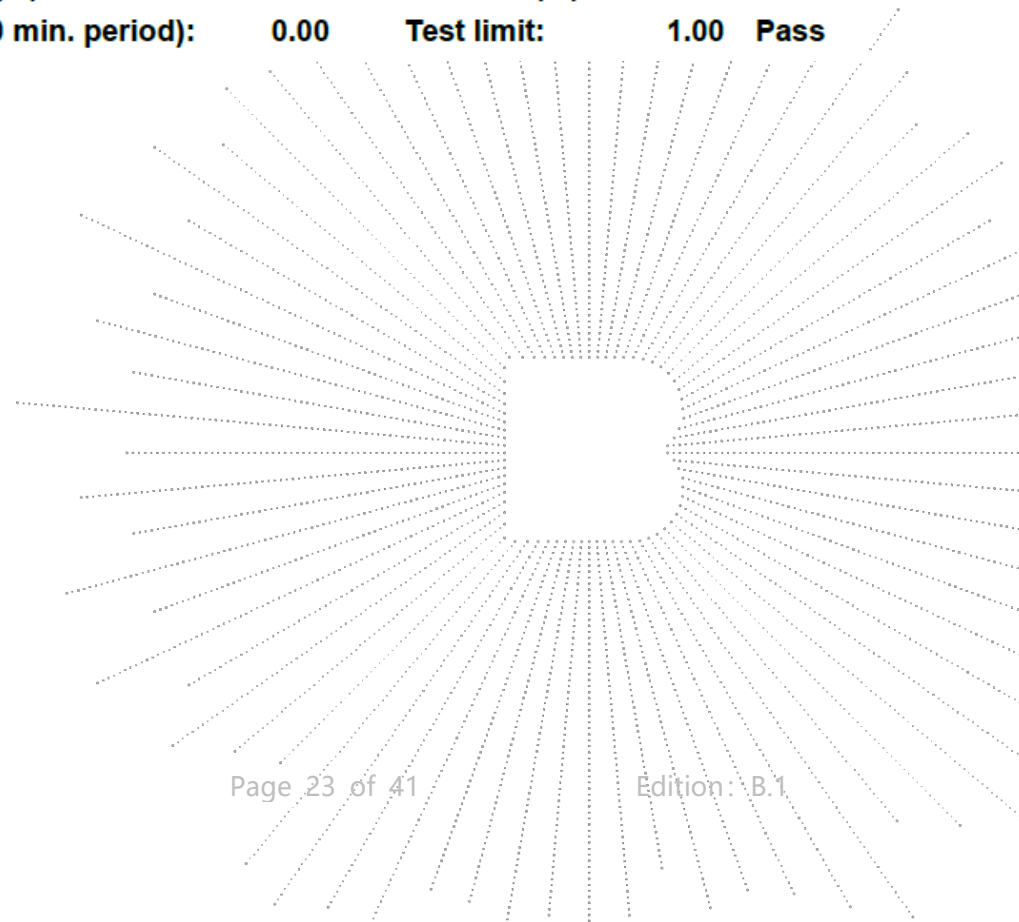

10. Immunity Test Of General The Performance Criteria

Product Standard	EN IEC 55014-2:2021 clause 6
CRITERION A	The apparatus shall continue to operate as intended during the test. No degradation of performance or loss of function is allowed below a performance level (or permissible loss of performance) specified by the manufacturer, when the apparatus is used as intended. If the minimum performance level or the permissible performance loss is not specified by the manufacturer, then either of these may be derived from the product description and documentation, and from what the user may reasonably expect from the apparatus if used as intended
CRITERION B	The apparatus shall continue to operate as intended after the test. No degradation of performance or loss of function is allowed below a performance level (or permissible loss of performance) specified by the manufacturer, when the apparatus is used as intended. During the test, degradation of performance is allowed, however, no change of actual operating state or stored data is allowed. If the minimum performance level or the permissible performance loss is not specified by the manufacturer, then either of these may be derived from the product description and documentation, and from what the user may reasonably expect from the apparatus if used as intended.
CRITERION C	Temporary loss of function is allowed, provided the function is self- recoverable or can be restored by the operation of the controls, or by any operation specified in the instructions for use.

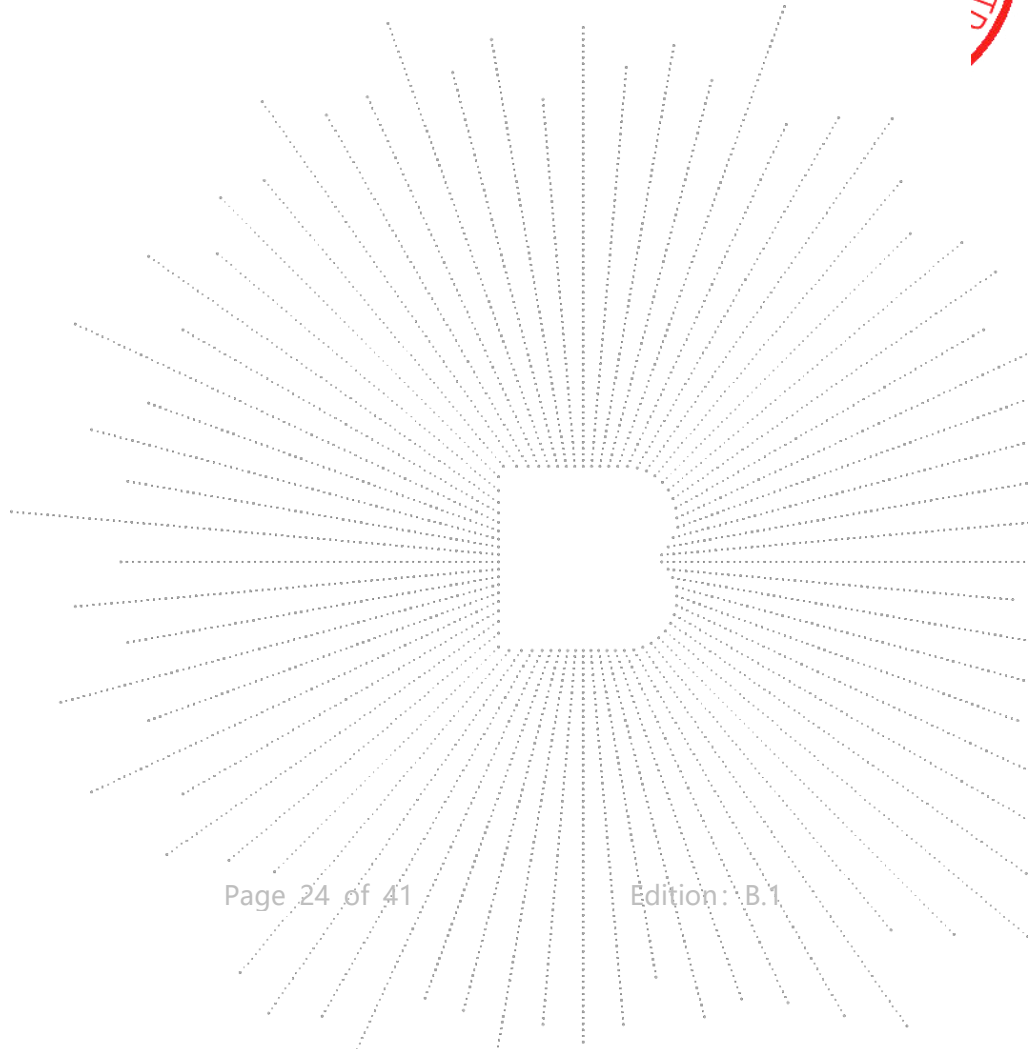
11. Electrostatic Discharge Immunity Test (ESD)

11.1 Test Specification

Basic standard	: IEC 61000-4-2
Test Port	: Enclosure port
Discharge Impedance	: 330 ohm / 150 pF
Discharge Mode	: Single Discharge
Discharge Period	: one second between each discharge

11.2 Block Diagram of Test Setup

For Floor Stand:

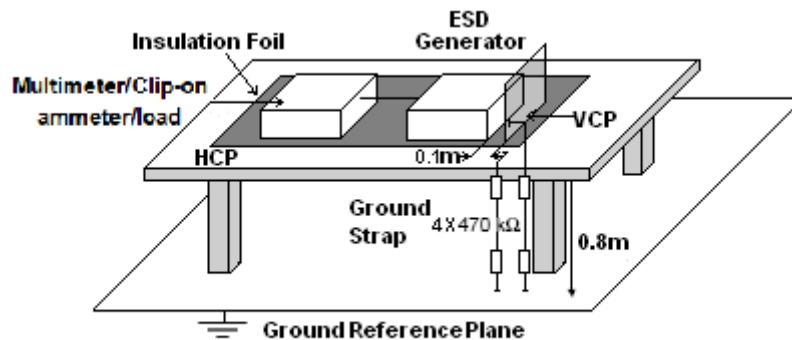

11.3 Test Procedure

- Electrostatic discharges were applied only to those points and surfaces of the Product that are accessible to users during normal operation.
- The test was performed with at least ten single discharges on the pre-selected points in the most sensitive polarity.
- The time interval between two successive single discharges was at least 1 second.
- The ESD generator was held perpendicularly to the surface to which the discharge was applied and the return cable was at least 0.2 meters from the Product.
- Contact discharges were applied to the non-insulating coating, with the pointed tip of the generator penetrating the coating and contacting the conducting substrate.
- Air discharges were applied with the round discharge tip of the discharge electrode approaching the Product as fast as possible (without causing mechanical damage) to touch the Product. After each discharge, the ESD generator was removed from the Product and re-triggered for a new single discharge. The test was repeated until all discharges were complete.
- At least ten single discharges (in the most sensitive polarity) were applied to the Horizontal Coupling Plane at points on each side of the Product. The ESD generator was positioned vertically at a distance of 0.1 meters from the Product with the discharge electrode touching the HCP.
- At least ten single discharges (in the most sensitive polarity) were applied to the center of one vertical edge of the Vertical Coupling Plane in sufficiently different positions that the four faces of the Product were completely illuminated. The VCP (dimensions 0.5m x 0.5m) was placed vertically to and 0.1 meters from the Product.

11.4 Test Results

Temperature:	26 °C	Relative Humidity:	54%
Pressure:	101kPa	Test Mode:	Working
Test Voltage :	AC 230V/50Hz		

Discharge Method	Discharge Position	Voltage (±kV)	Min. No. of Discharge per polarity (Each Point)	Required Level	Performance Criterion
Contact Discharge	Conductive Surfaces	4	10	B	A
	Indirect Discharge HCP	4	10	B	A
	Indirect Discharge VCP	4	10	B	A
Air Discharge	Slots, Apertures, and Insulating Surfaces	8	10	B	A

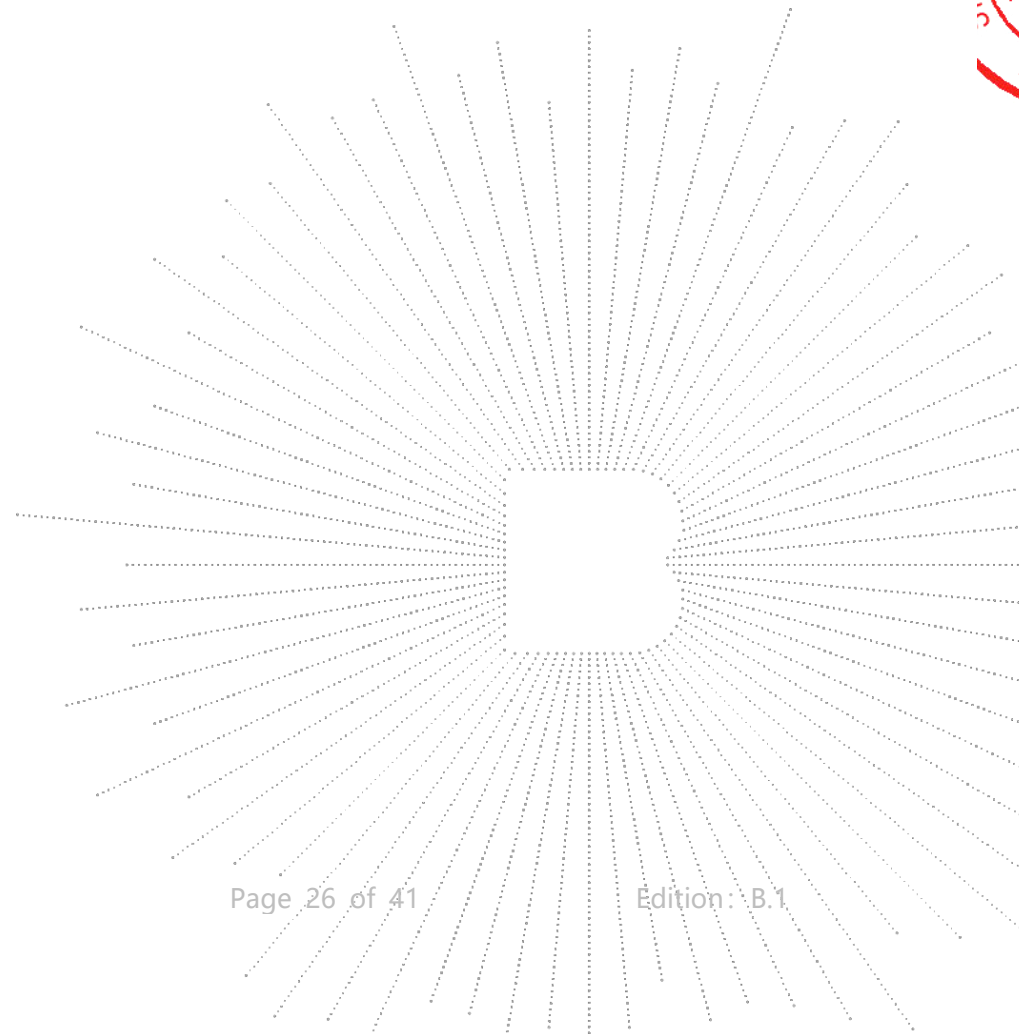

12. Fast Transients Immunity Test (EFT)

12.1 Test Specification

Basic standard	: IEC 61000-4-4
Test Port	: input a.c. power port
Impulse Frequency	: 5 kHz
Impulse Wave-shape	: 5/50 ns
Burst Duration	: 15 ms
Burst Period	: 300 ms
Test Duration	: 2 minutes per polarity

12.2 Block Diagram of EUT Test Setup

For input a.c. power port:

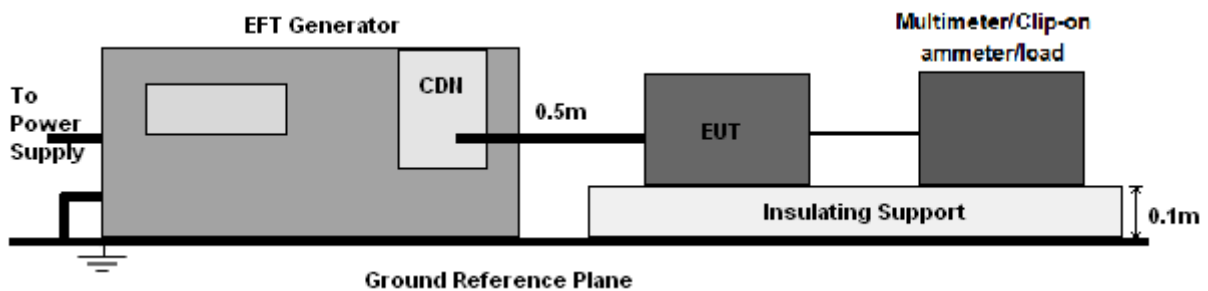

12.3 Test Procedure

- The Product and support units were located on a non-conductive table above ground reference plane.
- A 0.5m-long power cord was attached to Product during the test.

12.4 Test Results

Temperature:	26 °C	Relative Humidity:	54%
Pressure:	101kPa	Test Mode:	Working
Test Voltage :	AC 230V/50Hz		

Coupling	Voltage (kV)	Polarity	Required Level	Performance Criterion
AC MainsL-N-P	1.0	±	B	A

13. Surges Immunity Test

13.1 Test Specification

Basic standard	: IEC 61000-4-5
Test Port	: input a.c.power port
Wave-Shape	: Open Circuit Voltage - 1.2 / 50 us Short Circuit Current - 8 / 20 us
Pulse Repetition Rate	: 1 pulse / min.
Test Events	: Five positive polarity pulses at the 90° phase angel Five negative polarity pulses at the 270° phase angle

13.2 Block Diagram of EUT Test Setup

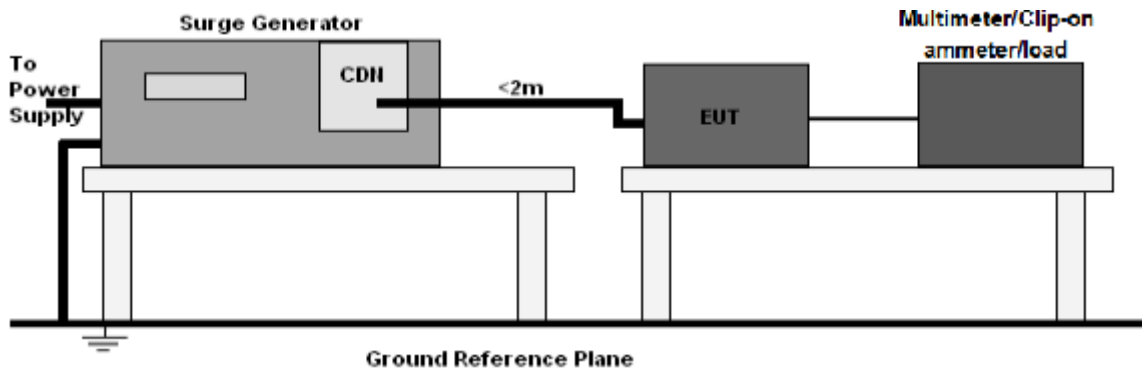

13.3 Test Procedure

- The surge is to be applied to the Product power supply terminals via the capacitive coupling network. Decoupling networks are required in order to avoid possible adverse effects on equipment not under test that may be powered by the same lines, and to provide sufficient decoupling impedance to the surge wave.
- The power cord between the Product and the coupling/decoupling networks shall be 2 meters in length (or shorter). Interconnection line between the Product and the coupling/decoupling networks shall be 2 meters in length (or shorter).

13.4 Test Result

Temperature:	26 °C	Relative Humidity:	54%
Pressure:	101kPa	Test Mode:	Working
Test Voltage :	AC 230V/50Hz		

Coupling Line	Voltage (kV)	Phase Angle	Required Level	Performance Criterion
L - N	+ 1	90°	B	A
	- 1	270°		
L - PE	+ 2	90°	B	A
	- 2	270°		
N - PE	+ 2	90°	B	A
	- 2	270°		

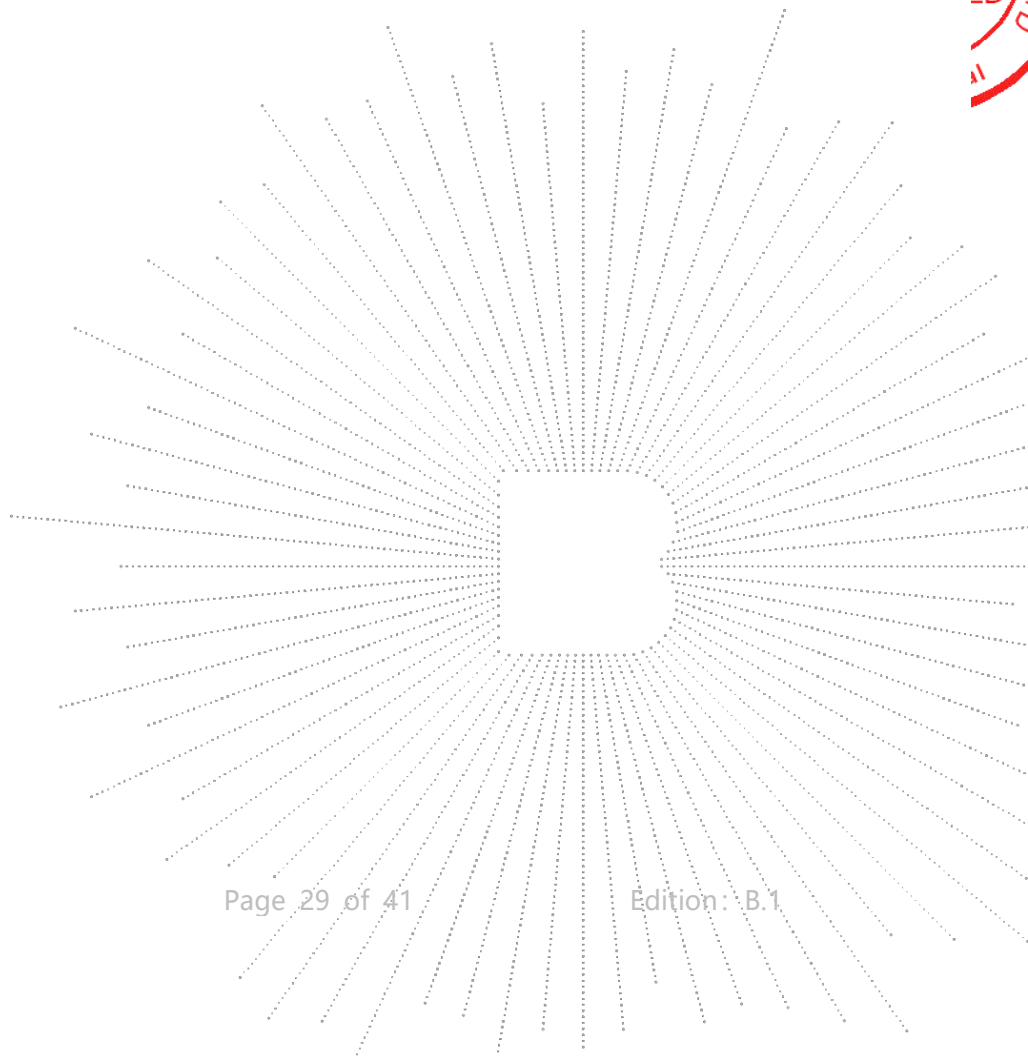

14. Injected Currents Immunity Test (CS)

14.1 Test Specification

Basic standard	: IEC 61000-4-6
Test Port	: input a.c. power port
Step Size	: 1%
Modulation	: 1kHz, 80% AM
Dwell Time	: 1 second

14.2 Block Diagram of EUT Test Setup

For input a.c. power port:

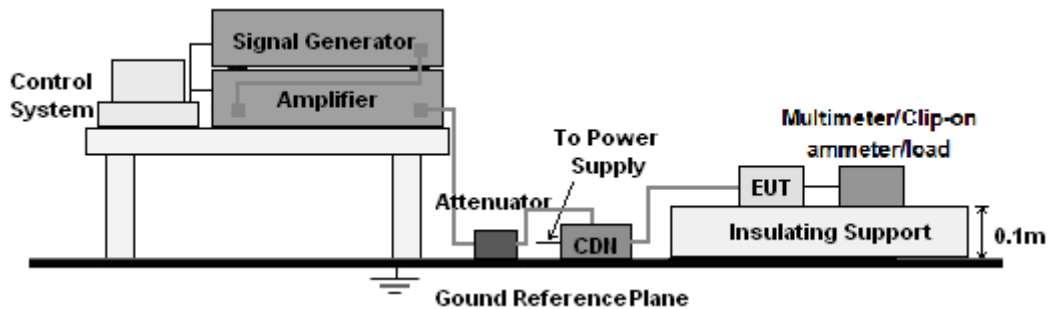

14.3 Test Procedure

For input a.c. power port:

- The Product and support units were located at a ground reference plane with the interposition of a 0.1 m thickness insulating support and the CDN was located on GRP directly.
- The frequency range is swept from 150 kHz to 230MHz, with the signal 80% amplitude modulated with a 1 kHz sine wave, and the step size was 1% of fundamental.
- The dwell time at each frequency shall be not less than the time necessary for the Product to be able to respond.

14.4 Test Result

Temperature:	26 °C	Relative Humidity:	54%
Pressure:	101kPa	Test Mode:	Working
Test Voltage :	AC 230V/50Hz		

Inject Line	Frequency (MHz)	Voltage Level (V r.m.s.)	Required Level	Performance Criterion
a.c. port	0.15 - 230	3	A	A

15. Voltage Dips And Interruptions Immunity Test (DIPS)

15.1 Test Specification

Basic standard	: IEC 61000-4-11
Test Port	: input a.c. power port
Phase Angle	: 0°, 180°
Test cycle	: 3 times

15.2 Block Diagram of EUT Test Setup

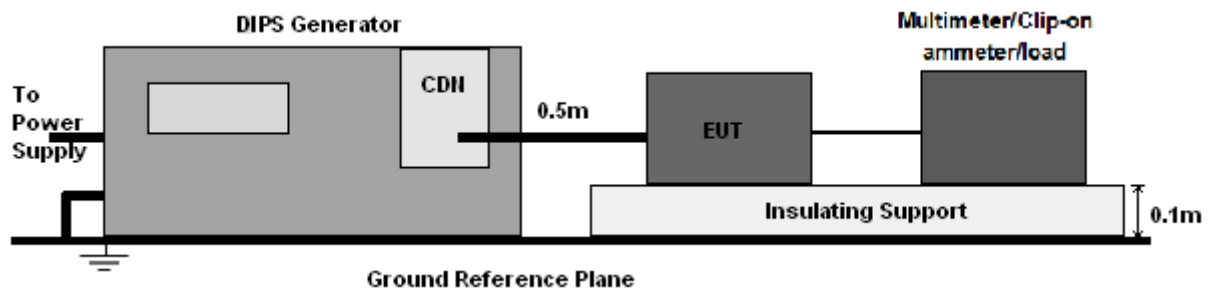

15.3 Test Procedure

- The Product and support units were located on a non-conductive table above ground floor.
- Set the parameter of tests and then perform the test software of test simulator.
- Conditions changes to occur at 0 degree crossover point of the voltage waveform.

15.4 Test Result

Temperature:	26 °C	Relative Humidity:	54%
Pressure:	101kPa	Test Mode:	Working
Test Voltage :	AC 230V/50Hz		

Test Level % U_T	Voltage dips in % U_T	Duration		Required Level	Performance Criterion
		50Hz	60Hz		
0	100	0.5	0.5	C	A
40	60	10	12	C	A
70	30	25	30	C	A

Remark: $T (s) = 1 / f (Hz)$

16. EUT Photographs

EUT Photo 1

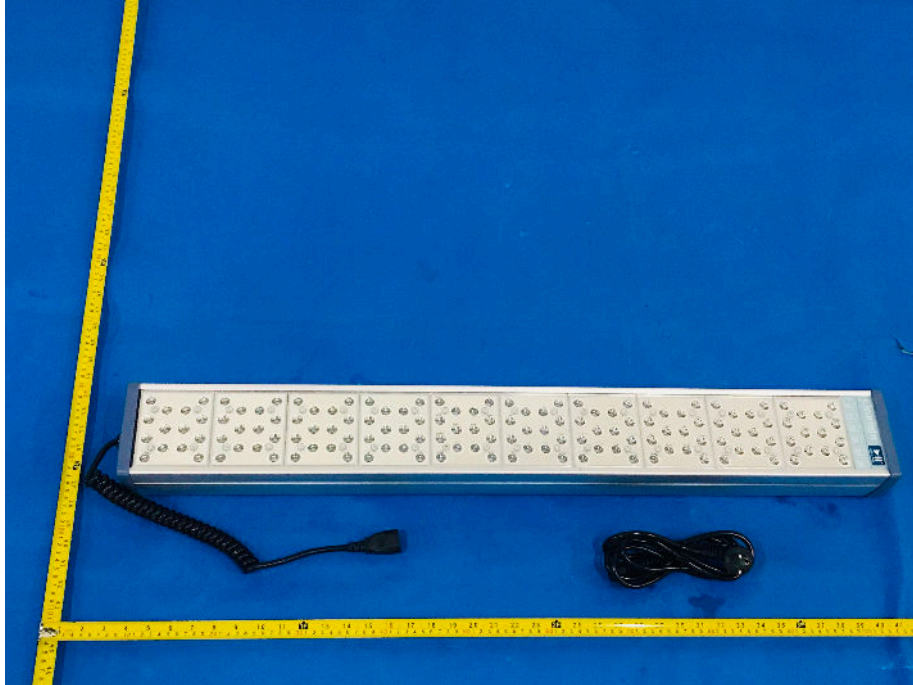

EUT Photo 2

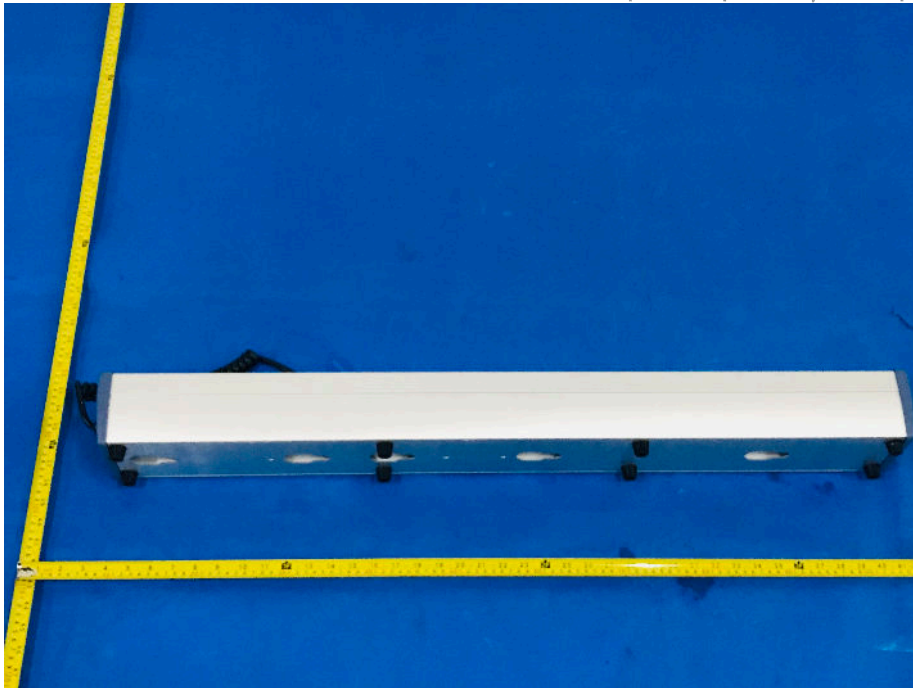

EUT Photo 3

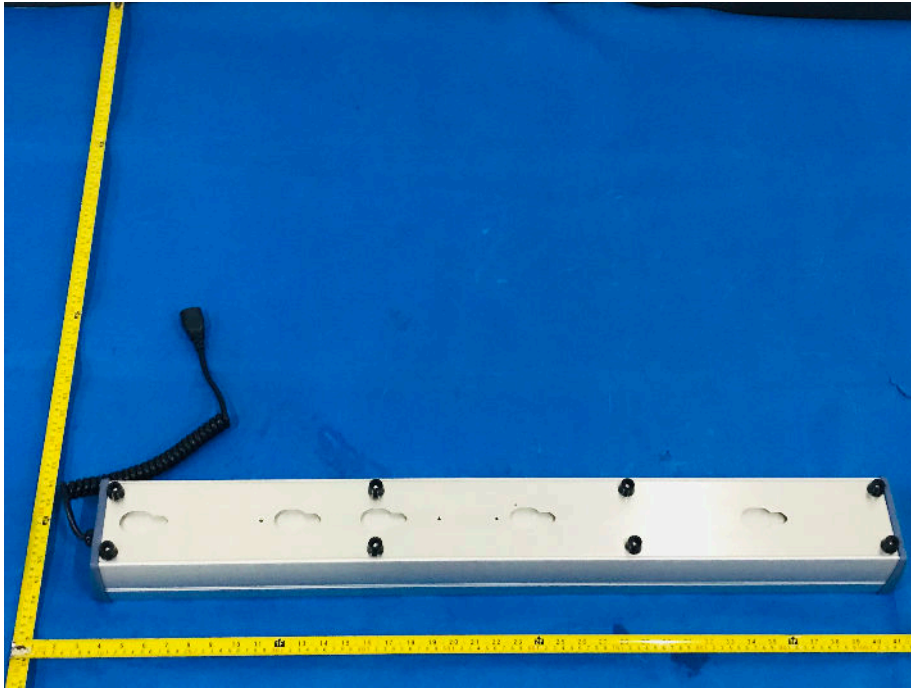

EUT Photo 4

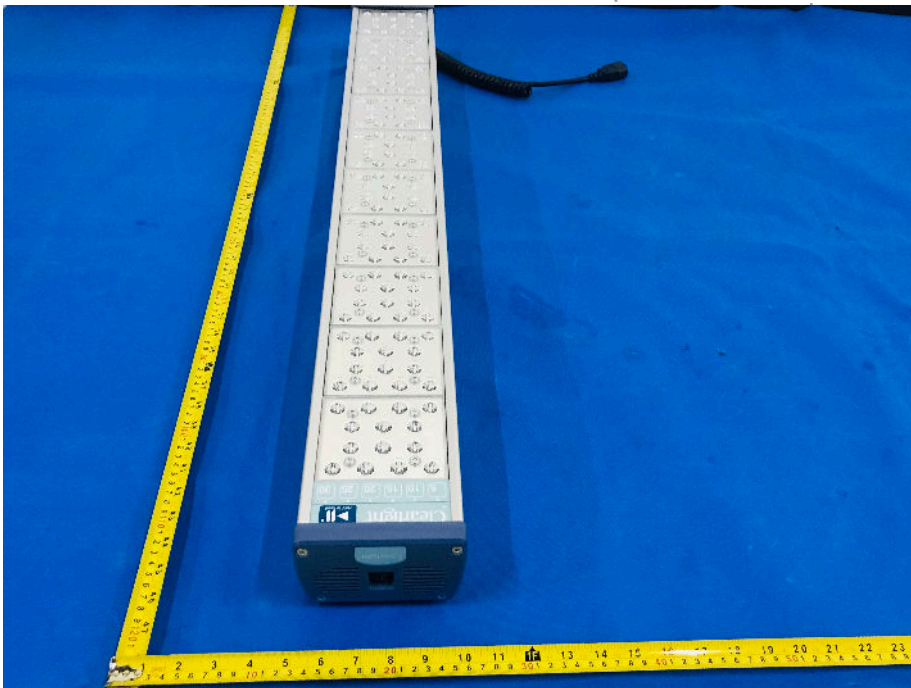

EUT Photo 5



EUT Photo 6



TEC
TC
OV
t See

EUT Photo 7

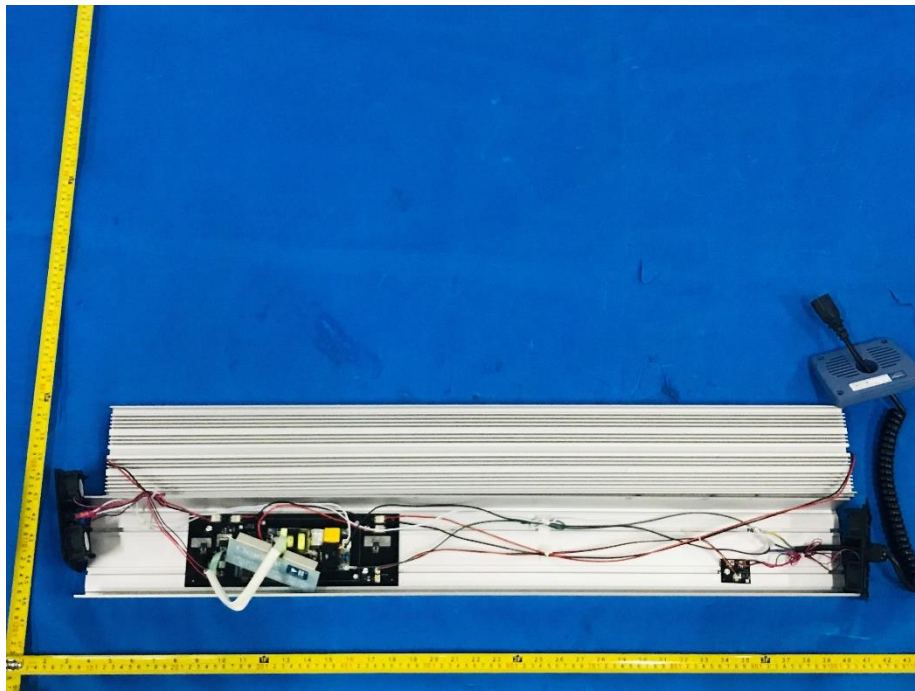

EUT Photo 8



EUT Photo 9

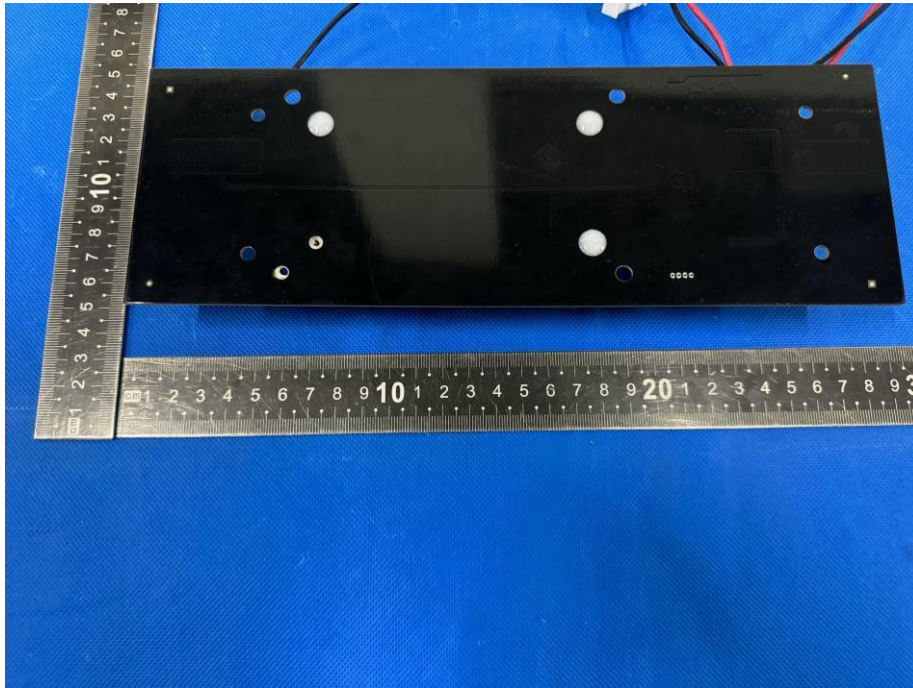

EUT Photo 10

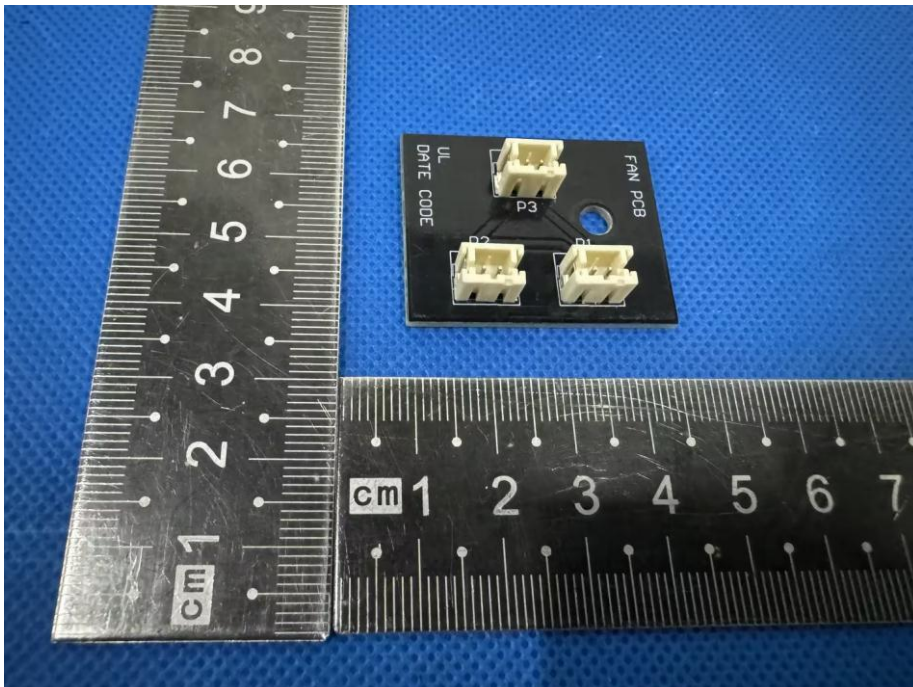

CO., LTD

EUT Photo 11

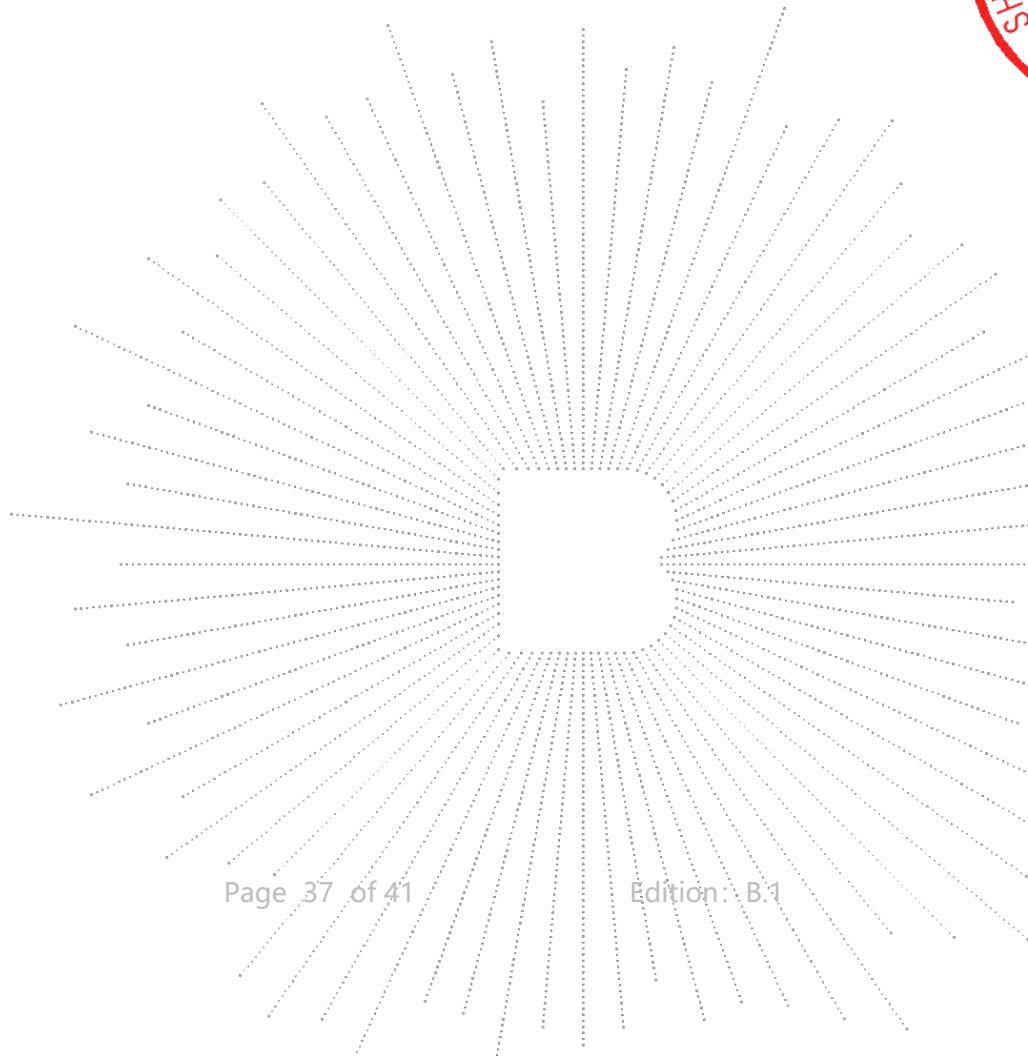
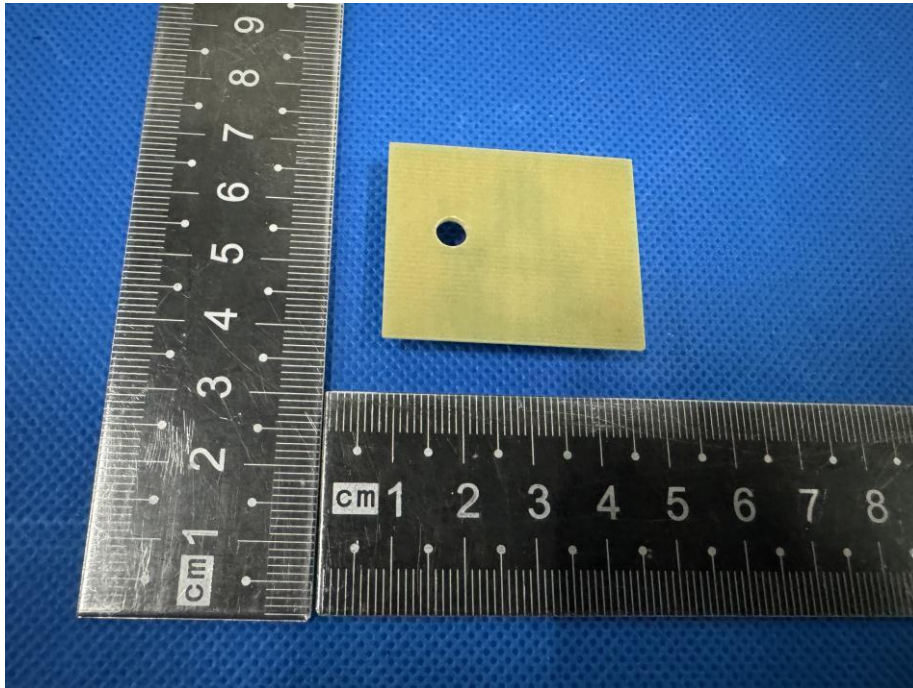

17. EUT Test Setup Photographs

Disturbance voltages



Radiated emissions

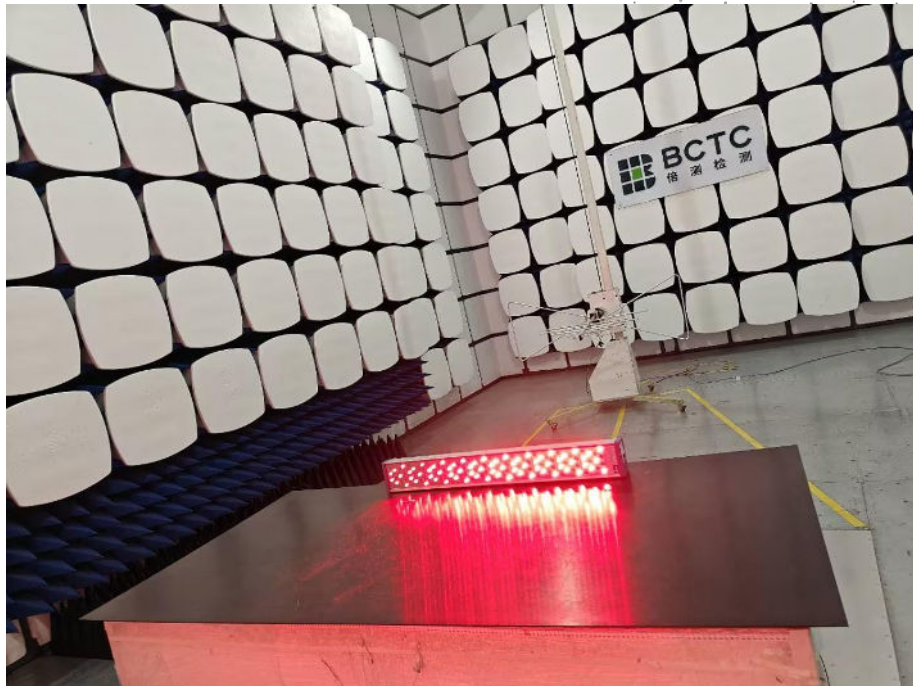

F/H

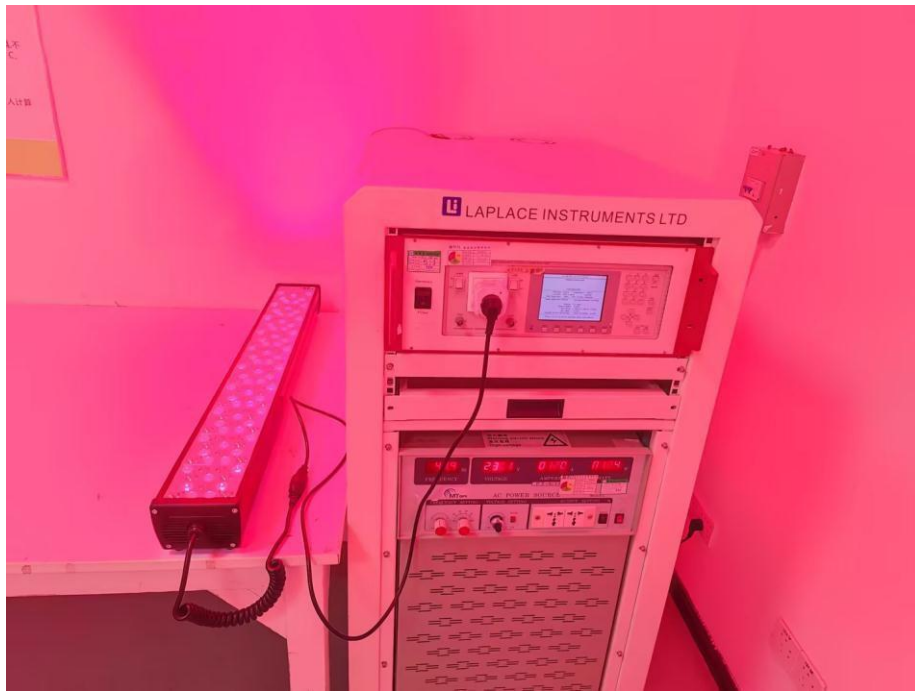

ESD



C T
CT
PROV
port S

EFT&SURGE&DIPS

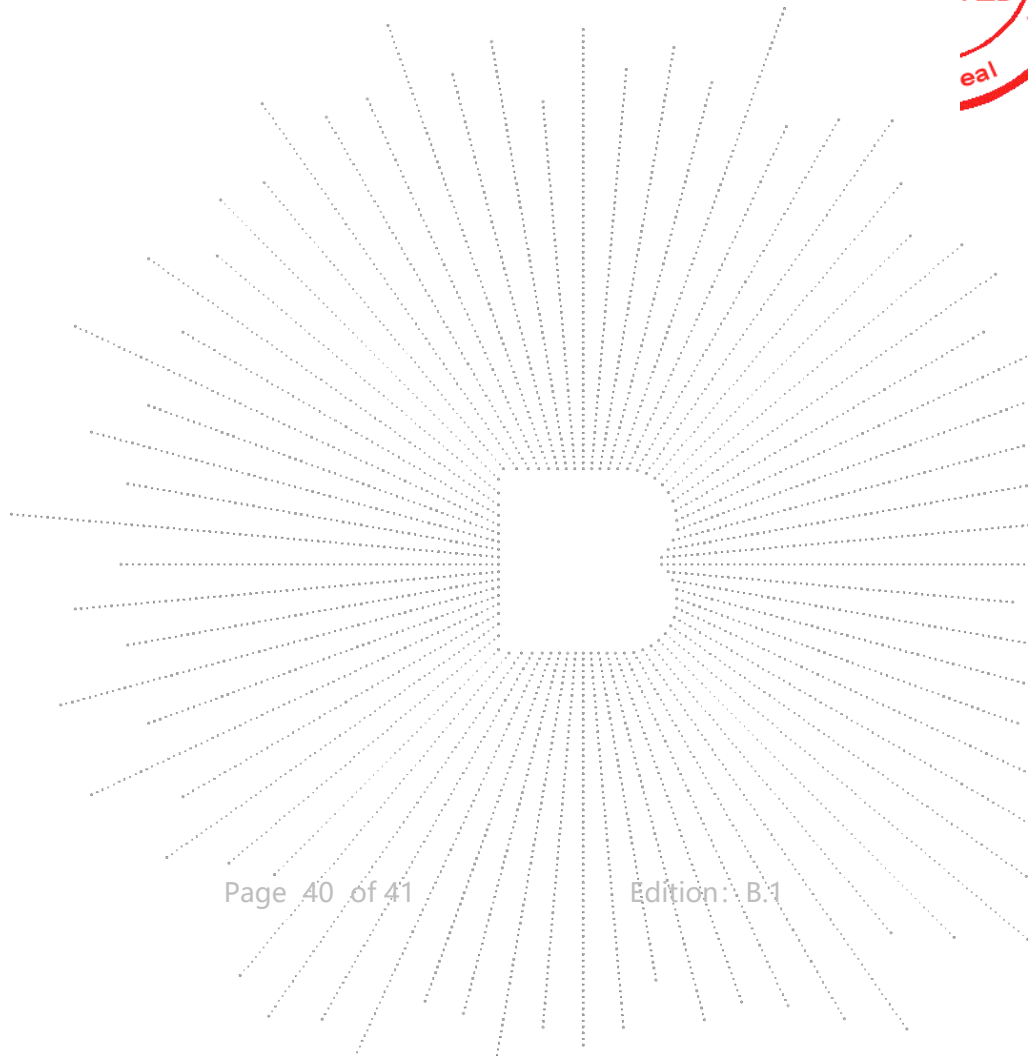

STATEMENT

1. The equipment lists are traceable to the national reference standards.
2. The test report can not be partially copied unless prior written approval is issued from our lab.
3. The test report is invalid without the "special seal for inspection and testing".
4. The test report is invalid without the signature of the approver.
5. The test process and test result is only related to the Unit Under Test.
6. Sample information is provided by the client and the laboratory is not responsible for its authenticity.
7. The quality system of our laboratory is in accordance with ISO/IEC17025.
8. If there is any objection to this test report, the client should inform issuing laboratory within 15 days from the date of receiving test report.

Address:

1-2/F., Building B, Pengzhou Industrial Park, No.158, Fuyuan 1st Road, Zhancheng, Fuhai Subdistrict, Bao'an District, Shenzhen, Guangdong, China

TEL: 400-788-9558

P.C.: 518103

FAX: 0755-33229357

Website: <http://www.chnbctc.com>

E-Mail: bctc@bctc-lab.com.cn

***** END *****